



## High Frequency Inverter Resistance Spot Welder

### Instruction Manual

---

Version 3.6n

## Table Of Contents

|  |    |
|--|----|
| <b>Quick start instructions</b> .....                  | 3  |
| <b>1 Introduction</b> .....                            | 4  |
| <b>2 Safety</b>  |    |
| 2.0 Safety & Environmental Specifications .....        | 5  |
| 2.1 General .....                                      | 5  |
| 2.2 Warnings and important notices .....               | 5  |
| 2.3 Safety devices .....                               | 7  |
| 2.3.1 Cooling .....                                    | 7  |
| 2.3.2 Overheat protection .....                        | 7  |
| <b>3 Installation</b>                                  |    |
| 3.1 General .....                                      | 8  |
| 3.2 Packaging and delivery inspection .....            | 8  |
| 3.3 Welder assembly .....                              | 8  |
| 3.4 Connection of electrical supply .....              | 9  |
| 3.4.1 Electrical Plug / Extension cords .....          | 9  |
| 3.5 Connection of pneumatic air supply .....           | 9  |
| <b>4 Operation</b>                                     |    |
| 4.1 Before you begin welding .....                     | 10 |
| 4.2 About your welder .....                            | 11 |
| 4.2.1 Welder Overview & Technical Specifications ..... | 11 |
| 4.2.2 Getting familiar with your welder .....          | 11 |
| 4.2.3 i4 Control Panel .....                           | 12 |
| 4.2.4 Indications on the Control Panel .....           | 12 |
| 4.2.5 i4 Service Panel Window .....                    | 12 |
| 4.3 Turning on the welder .....                        | 13 |
| 4.4 Choosing the weld mode .....                       | 14 |
| 4.5 Setting the pneumatic air pressure .....           | 15 |
| 4.6 Setting/Changing the weld program .....            | 15 |
| 4.7 Setting the weld time .....                        | 15 |
| 4.8 Setting the default weld programs .....            | 16 |
| <b>5 Double-Sided Welding</b>                          |    |
| 5.1 PS-500 Double-Acting Spot Gun .....                | 17 |
| 5.1.1 PS-500 Component Diagram .....                   | 17 |
| 5.1.2 Using the Double-Acting Gun .....                | 17 |
| 5.2 Extension Arms .....                               | 18 |
| 5.2.1 Switching to extension arms .....                | 18 |
| 5.2.2 Extension Arms and Welding Electrodes .....      | 19 |
| 5.3 PS-500 Electrode Alignment .....                   | 20 |
| 5.4 Removing Welding Electrodes .....                  | 21 |
| 5.5 Welding Electrode Maintenance .....                | 22 |
| 5.6 Wheel House Arm .....                              | 22 |
| 5.7 X-Adapter (optional) .....                         | 23 |
| 5.7.1 Attaching the X-Adapter .....                    | 23 |
| 5.7.2 Using the X-Adapter .....                        | 24 |

## Table Of Contents

|  |    |
|--|----|
| <b>5 Double-Sided Welding (Cont.)</b>                          |    |
| 5.7.3 X-Adapter Configurations .....                           | 24 |
| <b>6 Single-Sided Welding</b>                                  |    |
| 6.1 Single-Sided Welding Overview .....                        | 25 |
| 6.2 Single-Sided Spot Welding .....                            | 27 |
| 6.3 Stud Welding .....   | 27 |
| 6.4 Nut Welding .....  | 28 |
| 6.5 Dent Pulling with Spot Hammer .....                        | 28 |
| 6.6 Moulding Clip Rivet Welding .....                          | 29 |
| 6.7 Dent Pulling with Washers and Slide Hammer with Hook ..... | 29 |
| 6.8 Contact Shrinking .....                                    | 30 |
| 6.9 Carbon Rod Shrinking / Stretching .....                    | 30 |
| 6.10 Stitch Welding .....                                      | 31 |
| 6.11 Pro Pull Dent Pulling (optional) .....                    | 32 |
| 6.11.1 Selecting Pro Pull Weld Mode .....                      | 32 |
| 6.11.2 Pro Pull Component Diagram .....                        | 32 |
| 6.11.3 Pro Pull Assembly .....                                 | 33 |
| 6.11.4 Dent Pulling with Pro Pull .....                        | 33 |
| 6.11.5 Paintless Dent Pulling With Pro Pull .....              | 33 |
| <b>7 i4 Login Feature</b>                                      |    |
| 7.1 i4 Login Overview .....                                    | 34 |
| 7.2 Turning the Login Function Off .....                       | 34 |
| 7.3 Turning the Login Function On .....                        | 34 |
| 7.4 Switching Passwords .....                                  | 35 |
| 7.5 Setting Up Technician User Passwords .....                 | 35 |
| <b>8 i4 Log Feature</b>  |    |
| 8.1 i4 Log Instructions .....                                  | 36 |
| 8.2 Download the Log file for print .....                      | 37 |

## Quick start instructions



**WARNING!** Before turning the welder on, make sure it is connected to proper electricity by certified people. Connect air to the air inlet on back panel.



**ATTENTION!** Avant d'allumer le soudeur, vérifiez qu'il est connecté à l'électricité propre par des personnes certifiées. Connectez l'air à l'entrée d'air au panneau d'arrière.

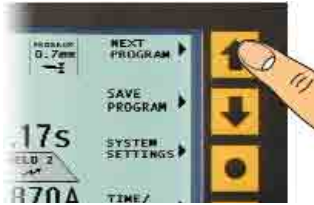
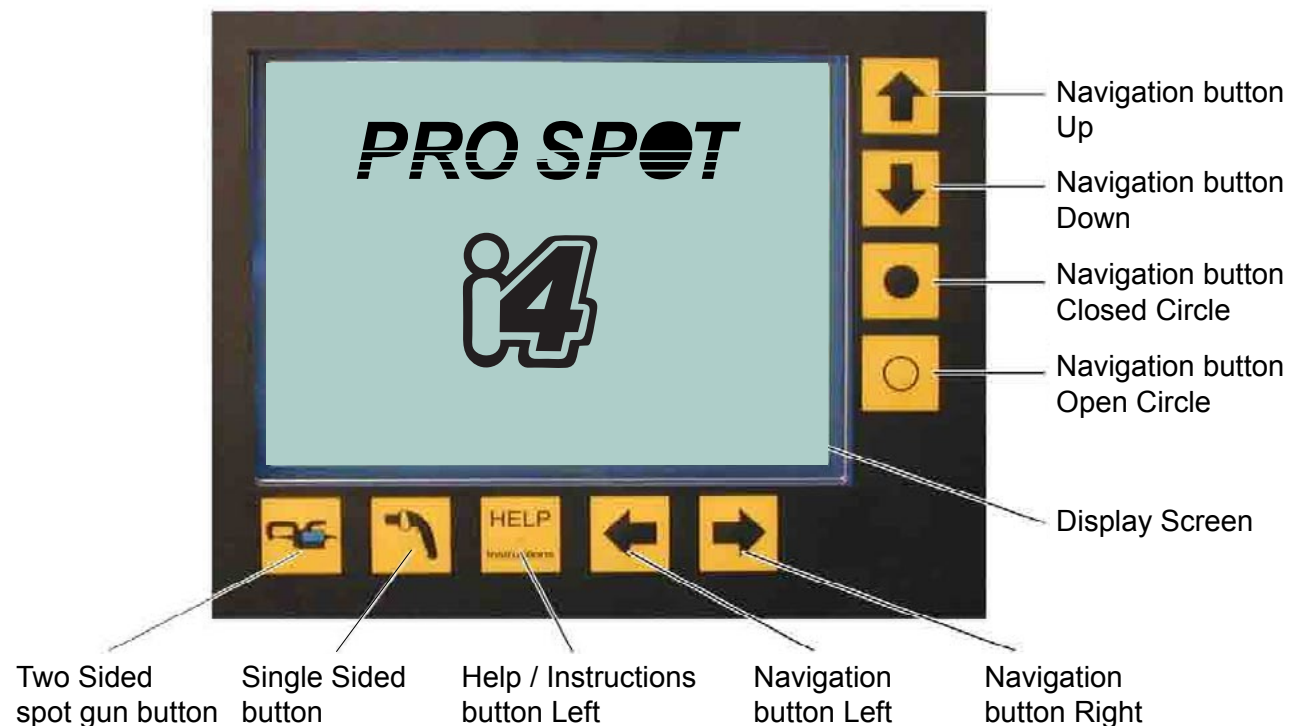

Figure 1.1



Figure 1.2

1. Turn the power switch on the front panel ON.
2. Connect Air to the air inlet located on the back panel.
3. During the test procedure a "Push Help to change language" prompt appears on the display screen. Click the Help button to access the System settings screen where the language can be changed. Select desired language by clicking the "Change Language" button, then exit.
4. After login procedure, the software defaults to HSS/Galv. Two Sided weld mode.
5. The welder is now ready to operate. Make sure air pressure is set at 90 PSI. Place the welding gun at the weld area and press the lower trigger button to weld. The upper weld button is for spreading the electrodes open for better access.
6. There are 6 different power levels pre-programmed into the i4. The software defaults to 0.7mm weld program, the thickness of one of the two layers of metal you are welding. To change between preset power settings press the Up Navigation button (fig. 1.1). The programs will switch between 0.7, 1.0, 1.2, 1.5, 2.0 and 2.5mm metal thickness.
7. To go to the next weld mode: "Mild Steel" press the Right Navigation button, (fig. 1.2). The same weld power levels are available in each weld mode. Navigate with the Right and Left arrow buttons and select weld power with the "Next Program" button (Up Navigation button).
8. Press the "Help" button anytime for instructions.
9. Turn the water cooling switch ON for welding jobs over 7 welds. Turn it OFF 5 min. after completion.



## 1 Introduction

Congratulations on acquiring your new PRO SPOT i4 welder!

Team Pro Spot looks forward to supporting you.

You have a welder and support group that will increase your productivity. The integrated features, ease of use, speed and quality welds that your i4 offers will become an important part of your business.

The following information will be needed when you call Pro Spot:

\* MODEL TYPE: i4

\* SERIAL NO: \_\_\_\_\_

The serial number is located on the back of the unit.

For parts or service contact your local distributor,

Local number: \_\_\_\_\_  
or in the U.S. call: Toll free:1-877 PRO SPOT or 1-760-407-1414  
for a customer service representative.

Visit Pro Spot On-Line: [www.prospot.com](http://www.prospot.com) E-mail: [info@prospot.com](mailto:info@prospot.com)

**NOTE:** You can now order parts online at: [prospot.com/store/](http://prospot.com/store/)

The i4 Spot welder is used by body shops to duplicate the welding procedure used by the car manufacturers. Use of the equipment that is contrary to the instructions in this manual can cause personal injury and/or machine damage.

Pro Spot International, Inc. can in no way be held responsible for intentional or unintentional damage, and consequent unlimited loss of profit, loss of income, loss of business opportunity, loss of use, etc. that originates from incorrect use of this equipment in its use in a manner not intended.

### Warranty

Pro Spot International, Inc. offers a two-year guarantee from the date of delivery of the new welder. This guarantee covers material defects and assumes normal care and maintenance.

The guarantee assumes that:

- the equipment is correctly installed and inspected
- the equipment has not been altered or rebuilt without approval from Pro Spot International, Inc.
- genuine Pro Spot International, Inc. spare parts are used to make repairs.
- operation and maintenance has been carried out according to the instructions in this manual.

All claims on warranty must verify that the fault has occurred within the guarantee period, and that the unit has been used within its operating range as stated in the specifications. All claims must include the product type and serial number. This data is stamped on the name plate.

**Note:** This instruction manual provides advice as well as instructions for installation, operation, maintenance and troubleshooting.



**IMPORTANT!** Read this manual carefully to become familiar with the proper operation of the welder. Do not neglect to do this as improper handling may result in personal injury and damage to the equipment.



**IMPORTANT!** Lisez ce Mode d'Emploi attentivement afin de vous familiariser avec le bon fonctionnement du soudeur. Ne négligez pas de le faire puisque une mauvaise manipulation peut conduire aux blessures et dommages à l'équipement.

The drawings in this manual are presented for illustrative purposes only and do not necessarily show the design of the equipment available on the market at any given time. The equipment is intended for use in accordance with current trade practice and appropriate safety regulations. The equipment illustrated in the manual may be changed without prior notice.

The contents in this publication can be changed without prior notice.

This publication contains information that is protected by copyright laws. No part of this publication may be reproduced, stored in a system for information retrieval or be transmitted in any form, in any manner, without Pro Spot International, Inc.'s written consent.

**Conformity with directives and standards:**  
i4 complies with CE standards.

## 2 Safety

### 2.0 Safety & Environmental Specifications

The i4 Spot welder is designed for indoor use - Protection Degree IP21S. The i4 Spot welder is designed to operate from -10° C to 40° C. The unit may be stored and transported in an ambient temperature from -20° C to +55° C. The unit can be operated at 95% Relative Humidity (RH). For operation above 1000m consult the manufacturer. Do not operate the unit on a slope of more than 10°. The unit meets the requirements of IEC|EN60974-1 2005 third edition and UL60974-1 2nd edition. E.M.C. classification is C1SPR11.

NOTE: Heating tests were performed at room ambient temperature and the duty cycle at 40° C has been determined by simulation.

### 2.1 General

The i4 Spot welder has been designed and is tested to meet strict safety requirements. Please read the following instructions carefully before operating the i4 and refer to them as needed to ensure the continued safe operation of the welder.

Information provided in this manual describes the suggested best working practices and should in no way take precedence over individual responsibilities or local regulations.

The i4 Spot Welder is designed to comply with all applicable safety regulations for this type of equipment. During operation, it is always each individual's responsibility to consider:

- Their own and other's personal safety.
- The safety of the welder through correct use of the equipment in accordance with the descriptions and instructions provided in this manual.

By observing and following the safety precautions, users of the i4 Spot welder will ensure safer working conditions for themselves and their fellow workers.

### 2.2 Warnings and important notices

The following types of safety signs are used on the equipment and in Pro Spot's instruction manuals:

|   |   |   |   |   |  |
|---|---|---|---|---|--|
|   |  | <b>Caution.</b><br>Read instruction manual.                                     |  |  | <b>Attention!</b><br>Lire Mode d'Emploi.   |
|  |   | <b>Prohibited.</b><br>Prohibits behaviour that can cause injury.                |  |   | <b>Interdit.</b><br>Interdit aux comportements qui peuvent provoquer des blessures.                            |
|  |   | <b>Command.</b><br>Calls for a specific action.                                 |  |   | <b>Commande.</b><br>Appelle à une action spécifique.   |
|  |   | <b>Warning.</b><br>Notice of personal injury risk and or damage to equipment.   |  |   | <b>Avertissement.</b><br>Avis de risque de blessure personnelle et / ou d'endommager l'équipement.             |
|  |   | <b>Warning.</b><br>Some parts of the welder may become hot after prolonged use. |  |   | <b>Avertissement.</b><br>Certaines parties du soudeur peuvent devenir chaudes après une utilisation prolongée. |

The following warnings and important notices are used in the instruction manual:

|   |   |   |   |
|---|---|---|---|
|    | <b>WARNING!</b> Do not operate or place the welder near water, in wet locations or outdoors. Risk for injuries or damage to the welder.   |    | <b>ATTENTION!</b> Ne pas faire fonctionner le soudeur près de l'eau, en voie humide, ou à l'extérieur. Risque de blessures ou de dommages au soudeur.   |
|    | <b>WARNING!</b> Do not place the welder on unstable or uneven ground. The welder might tip causing personal injuries or serious damage to the welder.                               |    | <b>ATTENTION!</b> Ne placez pas le soudeur sur un sol instable ou irrégulière. Le soudeur peut basculer causant des lésions corporelles ou des dommages graves au soudeur.  |
|    | <b>WARNING!</b> All electrical connections must be made by a qualified electrician. Risk for electrical shock.  |    | <b>ATTENTION!</b> Toutes les connexions électriques doivent être faites par un électricien qualifié. Risque de choc électrique.   |
|    | <b>WARNING!</b> Loose cables and hoses present tripping risks. Risk for injuries.   |    | <b>ATTENTION!</b> Câbles et tuyaux lâches présentent des risques de déclenchement. Risque de blessures  |
|    | <b>WARNING!</b> Make sure to use welding goggles when spot welding. The sparks might otherwise injure the eyes.   |    | <b>ATTENTION!</b> Veuillez utiliser des lunettes de soudeur sur place. Les étincelles pourraient autrement blesser les yeux.  |
|    | <b>WARNING!</b> Sparks from welding could start a fire. Risk for injuries.  |    | <b>ATTENTION!</b> Étincelles de soudure pourrait provoquer une incendie. Risque de blessures.   |
|   | <b>WARNING!</b> Risk for damage to materials close to the weld, e.g to glass or textiles.   |   | <b>ATTENTION!</b> Risque de dommages aux matériaux à proximité de la soudure, par exemple verre ou textiles.  |
|  | <b>WARNING!</b> For proper cooling efficiency, never operate the welder without connecting it to the compressed air source.   |  | <b>ATTENTION!</b> Pour refroidissement efficace, ne jamais soudeur sans attacher à la source d'air comprimé.  |
|  | <b>WARNING!</b> All service and maintenance must be carried out by Pro Spot service personnel and service support. Risk for electrical shock.                                       |  | <b>ATTENTION!</b> Tout le service et l'entretien doivent être effectués par personnel et soutien de service Pro Spot. Risque de choc électrique.  |
|  | <b>WARNING!</b> Unplug the welder from the wall outlet before servicing, cleaning or maintenance. Risk for electrical shock.  |  | <b>ATTENTION!</b> Débranchez le soudeur de la prise murale avant l'entretien, ou nettoyage. Risque de choc électrique.  |
|  | <b>IMPORTANT!</b> The i4 welder may only be used by qualified personnel. The user of the welder must have knowledge of spot welding and of alignment of collision-damaged vehicles. |  | <b>IMPORTANT!</b> Le soudeur i4 peut seulement être utilisé par personnel qualifié. L'utilisateur du soudeur doit avoir une connaissance de soudage par points et l'alignement des véhicules endommagés par collisions. |
|  | <b>IMPORTANT!</b> Do not turn off the welder while cooling is activated!  |  | <b>IMPORTANT!</b> N'éteignez pas le soudeur pendant que le refroidissement est activé!  |
|  | <b>IMPORTANT!</b> The air must be clean and free from oil and moisture. Use filter.   |  | <b>IMPORTANT!</b> L'air doit être propre et sans huile et humidité. Utilisez un filtre  |

## 2.3 Safety devices

### 2.3.1 Cooling



Figure 2.1



Figure 2.2



Figure 2.3

When the Spot Gun is used continuously, the welding cables and the power transformer get hot. To prevent the welder from malfunctioning due to overheating, it is cooled using the built-in air, and liquid cooling systems. The air cooling system cools the welding cables and the water cooling system cools the transformer, inverters, cable ends and the spot gun.

i4 features an air cooling system that cools all four welding cables. There are two different Cooling Modes: "AUTO" (default) and "MANUAL". In the "AUTO" mode, the air cooling system turns on automatically after 15-30 welds and forced air starts to flow through the cable. In the "MANUAL" mode the cooling system operates continuously.

To switch to "MANUAL" mode:

- 1) Restart the software and press "HELP" button while start-up screen is displayed. "System Settings" screen will display (fig. 2.1).
- 2) Select "System Settings" by pressing the Navigation button, Up (fig. 2.2).
- 3) Select "Manual Cooling" by pressing the Navigation button, Down (fig. 2.3). AIR COOLING will activate.

The Liquid Cooling system is turned ON and OFF with the switch on the Front Panel (fig. 2.3a). The water tank is located in the rear of the unit, inside the center column. The watertank should be filled with a 50/50 water & antifreeze solution (fig. 2.3b).



Figure 2.3a



Figure 2.3b

### 2.3.2 Overheat protection

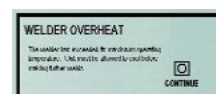

Figure 2.4

The built-in overheat protection is designed to prevent damage to the welder caused by overheating. The system will automatically shut off the welder when a pre-programmed temperature is reached (fig. 2.4). DO NOT turn off the welder! It needs the cooling air to cool the machine faster. Wait until the display returns to normal (usually 4-8 min.) Shorter duty cycles (due to short weld times and "rest" periods between welds) will allow the cooling system to function better and may prevent the auto-shut-off. (Consistently check weld strength by performing destructive tests).

For continuous use do not exceed 3 welds per minute. For operation not exceeding 60 minutes: 6 welds per minute. Welding current 9270A for continuous use 12,500A maximum at 1 weld per minute for 5 minutes max.

**IMPORTANT!** Do not turn off the welder while the cooling system is activated!

**IMPORTANT!** If the thermal breaker has switched off the welder, please contact Pro Spot's authorized service personnel

**IMPORTANT!** Leave the water cooling ON for faster cool down

**IMPORTANT!** N'éteignez pas le soudeur pendant que le système de refroidissement est activé!

**IMPORTANT!** Si le disjoncteur thermique a éteint le soudeur, s'il vous plaît contactez personnel de service autorisé Pro Spot.

**IMPORTANT!** Laissez couler l'eau de refroidissement à l'intention de se refroidir plus rapidement.

## 3 Installation

### 3.1 General

The i4 Spot welder is inspected and tested prior to leaving the factory to guarantee consistent quality and the highest possible reliability. Follow the installation tips and operating instructions below to ensure user safety and proper welder performance.

**WARNING!** Do not operate or place the welder near water, in wet locations or outdoors. Risk for injuries or damage to the welder.

**WARNING!** Do not place the welder on unstable or uneven ground. The welder might fall causing personal injuries and damage to the welder. Do not operate on a slope of more than 10°.

**IMPORTANT!** It is the responsibility of the owner to ensure that the equipment has been installed as specified in the instructions provided. It is also the owner's responsibility to ensure that the welder is inspected in accordance with applicable regulations before it is put into service. Do not use for thawing out frozen water pipes (17.1)

**ATTENTION!** Ne pas faire fonctionner le soudeur près de l'eau, en voie humide ou à l'extérieur. Risque de blessures ou de dommages au soudeur.

**ATTENTION!** Ne placez pas le soudeur sur un sol instable ou irrégulière. Le soudeur peut tomber causant des dommages graves au soudeur. Ne pas utiliser sur une pente de plus de 10°

**IMPORTANT!** C'est la responsabilité du propriétaire de s'assurer que l'équipement a été installé comme spécifié dans les instructions fournies. C'est aussi la responsabilité du propriétaire de s'assurer que le soudeur est inspecté conformément à la réglementation applicable avant qu'il ne soit mise en service. Ne pas utiliser pour dégelier les conduites d'eau congelées (17.1)

A grounded electrical plug must be installed (refer to section 3.4 "Connection of electrical supply").

### 3.2 Packaging and delivery inspection

Check the contents of the shipping container against the packing list, consignment note, or other delivery documentation to verify that everything is included and in the correct quantity. Check the i4 Spot Welder carefully to make sure that no damage has occurred during transport. If anything is damaged or missing, the welder may be unsafe to use till the part is repaired or replaced. If anything is missing, please contact your supplier. Remove all packaging material from the welder.

### 3.3 Welder assembly

For your convenience, i4 welder ships fully assembled.

Due to differences in wiring codes and connection methods, no electrical plug comes with the welder. Consult a certified electrician for proper installation of the electrical plug.

Insert the support arm (boom) as shown in Figure 3.1



Figure 3.1

### 3.4 Connection of electrical supply

The i4 Spot Welder requires one of the following voltage / frequency combinations:

- ✓ 208-240V 50/60 Hz U.S.A., Canada, Japan *OR*
- ✓ 400-420V 50/60 Hz Europe, Australia

**Note:** Make sure that the facility supply voltage and frequency are the same as shown on the welder name plate (see section 4.2 "About your welder").

The power supply must have a ground connection. The supply must also be protected as follows:

- ✓ The 208-240V 3-Phase or Single-Phase require 60A breaker.
- ✓ The 400V and 420V supply require a 32A slow blow fuse (Circuit breaker 32D).



**WARNING!** All electrical connections must be made by a qualified electrician. Risk for electrical shock.



**ATTENTION!** Toutes les connexions électriques doivent être faites par un électricien qualifié. Risque de choc électrique.

1. Connect the green wire to ground.

**Note:** Make sure that the supply cable is at least 6 AWG at 208V and 400 V.  
The i4 is rated for over voltage category III and pollution degree 3.

#### 3.4.1 Electrical Plug / Extension cords

2. If an extension cord is used with the welder, ensure that the length of the extension cord does not exceed 10 m (30 ft) and it meets the specifications of Item 1 above. The cord must also be grounded. Consult an electrician for safe and proper installation of the electrical plug.

**NOTE:** When connecting the welder to Single-Phase input power, install Red and White wires. Connect Green to earth ground! **Leave out the black wire.** Insulate and store the black wire properly.

### 3.5 Connection of pneumatic air supply

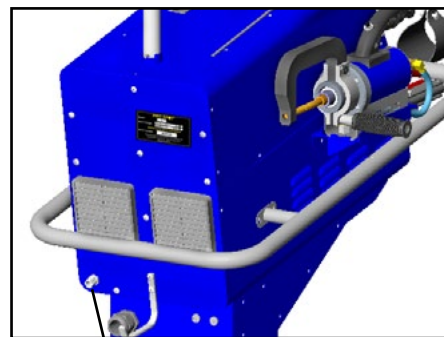

Figure 3.2

The i4 Spot welder must be connected to a pneumatic air network. (100 PSI to 130 PSI)

1. Connect the i4 to the air supply via the threaded input port at the rear of the welder using a standard connector.
2. If not already set, adjust the air pressure setting on the welder front panel to 60 PSI (4-5 bar) (refer to section 4.5 "Setting the pneumatic air pressure").



**IMPORTANT!** The air must be clean and free from oil and moisture. Use a filter.



**IMPORTANT!** L'air doit être propre sans huile et humidité. Utilisez un filtre.

Air supply port

## 4 Operation

### 4.1 Before you begin welding

Before you begin welding, be sure to read and understand the following instructions.

The Pro Spot i4 is a state-of-the-art Inverter Resistance Spot Welder that was designed for the collision repair industry. It duplicates the welding procedure used by the car manufacturers. It is important to understand the design and function of this welder before operating it.

**ELECTRICITY ONLY:** The i4 uses only electricity to create the welds unlike the MIG welder which uses an arc from a feeding wire to build a weld nugget using inert gas and the feeding wire material.

**PRESSURE:** The i4 has a built in air cylinder that compresses the Double-Sided Gun's welding tips together automatically when triggered. The compression is an important part of a good resistance weld. The pressure is adjustable from the Control Panel. The optimum welding pressure varies between 60-90 PSI (4-6.5 BAR). 90 PSI seems to be a common starting pressure. As a rule, increase pressure with thicker metals but remember that too much pressure could decrease the resistance of the metal between the electrodes, resulting in poor weld penetration.

**CURRENT:** Another important aspect of a weld is the current applied through the work piece. A weld is created when a large current is transferred through the layers of sheet metal. The resistance in the metal causes the area to heat up and fuse the sheets together in a nugget.

**WELD PROGRAM:** Maintaining the air pressure after the current shuts off makes the weld cool down under pressure resulting in a harder, stronger weld. This feature is built in to the i4's weld control program and is engaged automatically during a weld cycle.

**TIME:** The Timer controls the duration of the current applied during the weld cycle. The ideal is to get a weld that uses higher current and shorter time to control heat buildup.

## 4.2 About your welder

### 4.2.1 Welder Overview & Technical Specifications

The welder is supplied with one of the following voltage and frequency combinations:

**Input voltage:** 3 phase  
208-240V 50/60 Hz. OR  
400-420-480V 50/60 Hz.

The actual voltage and frequency is stated on the rear panel name plate. Open circuit output voltage 20v max. E.M.C. classification is C1SPR 11.

**Welding amperage:** 12500A max (3-phase)  
**Cable length:** 8' (2.5m) standard  
**Electrode Pressure:** At 7 bars (90 PSI)-280 DaN (616 Lb)  
At 9.5 bars (135 PSI)- 420 DaN (924 Lb)

**Cooling system:** Air (2 fans), Compressed air (weld gun and weld cables)  
Water Cooling (inverter, transformer, welding gun)

**Micro processor:** i4 Upgradeable Software Platform  
**Shipping Weight (standard):** 373lb (169kg)



The name plate is at the rear of the welder unit. The required voltage is indicated on the label. Welding output is rated at 15V.

### 4.2.2 Getting familiar with your welder

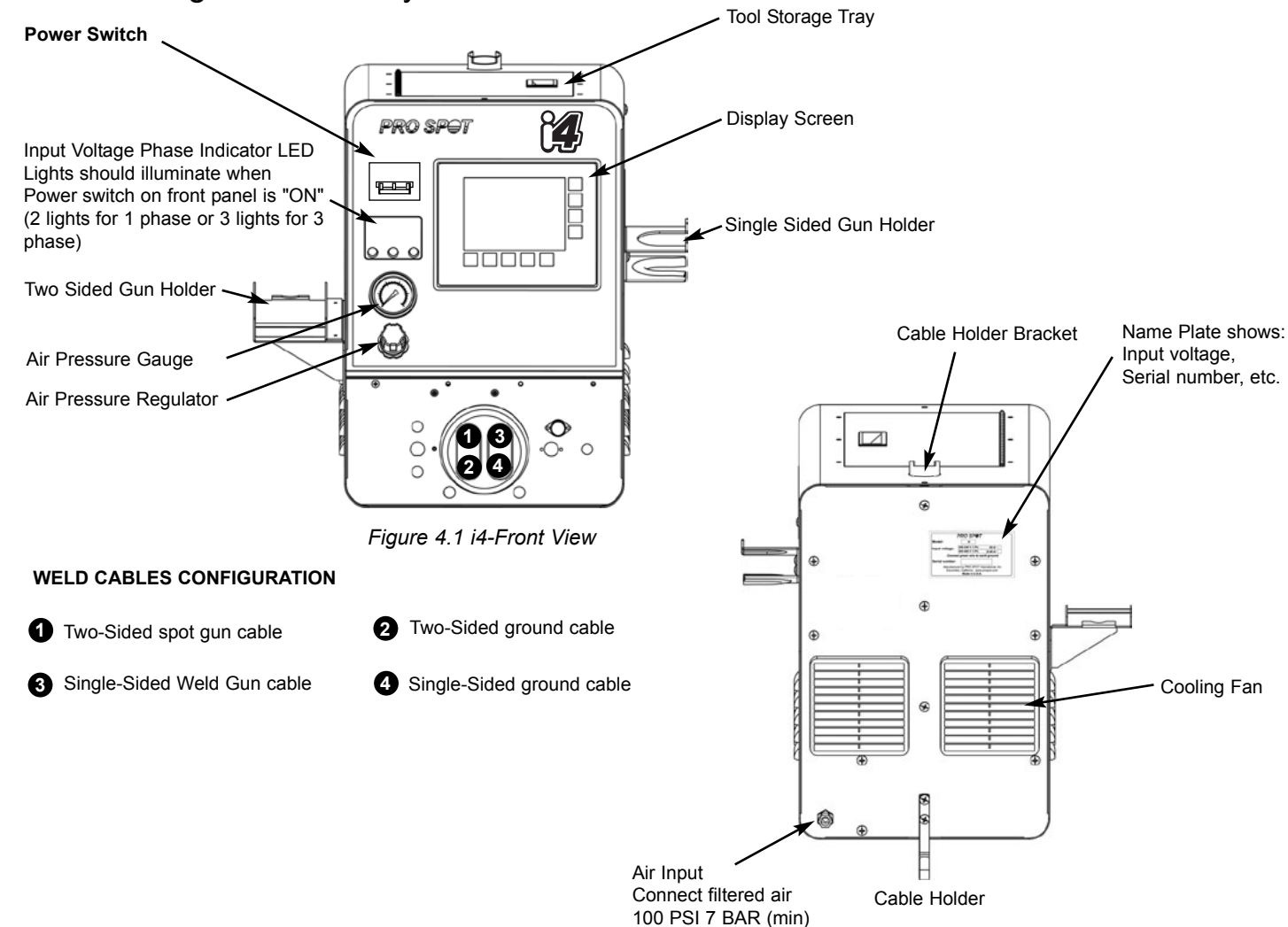

Figure 4.1 i4-Front View

Figure 4.2 i4-Back View

### 4.2.5 Service Panel Window – Control System Status Lamps

Location: Inside the i4 and PR-2000 tool & accessory tray (under the rubber mat).

Purpose: To quickly determine the status of many internal systems without opening the welder. The welder needs to be powered up. Look down through the window. There are several lights to watch for. The Voltage Indicator windows have three LED lights in each window, while the IGBT and Bus Bar windows have only one light per window.

NOTE: D means diode while the number determines the device's board location.

1) Bus High Voltage OK: LED1 & 2 indicate 300 volts DC present. Both stay ON (but often only one of them is seen unless top cover is removed).

D06= present  
D26= present.

2) IGBT Control System OK: LEDs 1, 2, 3, 4 indicate voltage present across each IGBT gate. Each LED should stay ON. LED 5 (yellow) indicates 15VDC control voltage and should stay ON. These diodes are on a separate, vertically-mounted mini-board.

D107 = present  
D108 = present  
D109 = present  
D110 = present  
D101= 15V present

3) AC Input - Voltage Drop Condition: LEDs 4, 5, 6 indicate a problem if any of them comes ON during welding. They all come on briefly during startup then stay OFF.

D23= Primary voltage drop 10%,  
D22= Primary voltage drop 15%  
D21= Primary voltage drop 20%

4) DC Voltage Indicators, LED 1, 2, 3 indicate logic voltages generated and present. They come ON during startup and stay ON.

D10= 15V present  
D11= 18V present  
D12 = 24V present



Service Panel Window – Control System Status Lamps

Tool tray mat removal required to view Service Panel Window.

### 4.2.3 i4 Control Panel

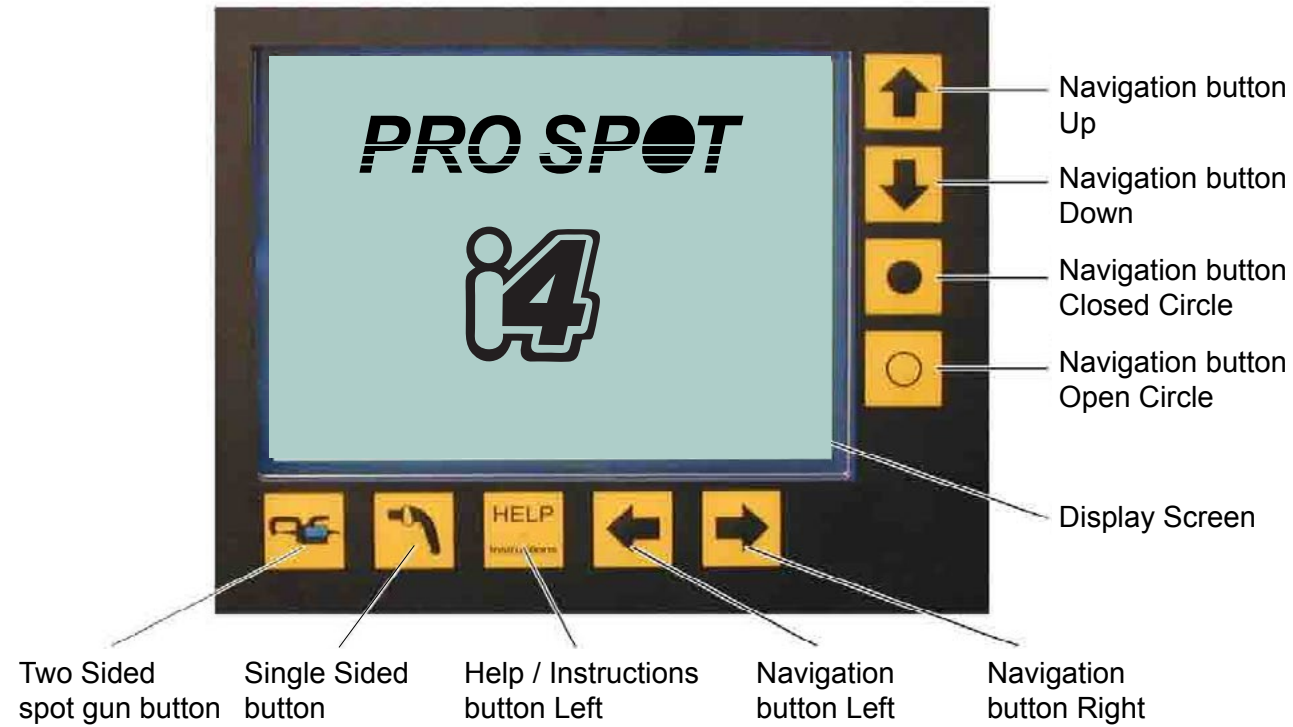

Figure 4.3 The i4 Control Panel

### 4.2.4 Indications on the Control Panel



Figure 4.4



Figure 4.5

When two sided welding is selected, a spot gun graphic appears in the upper-left corner of the display screen (fig. 4.4).

When single sided welding is selected, a single sided gun graphic appears in the upper-left corner of the display screen (fig. 4.5).

### 4.3 Turning on the welder

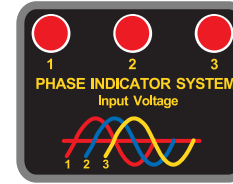

Figure 4.5.1

1. Toggle the circuit breaker on the front panel to "ON". Three lights on the front panel should illuminate indicating 3-phase installation, 2 lights for 1-phase installation (fig. 4.5.1)
2. The display will go through the start-up procedure.
3. The i4 is now ready to use.

**IMPORTANT!** Make sure to read the instruction manual before operating the welder. Only trained personnel should use this welder.

**IMPORTANT!** Assurez-vous de lire le Mode d'Emploi avant d'opérer le soudeur. Seul le personnel qualifié devrait utiliser ce soudeur.

### 4.3.1 Login Procedure

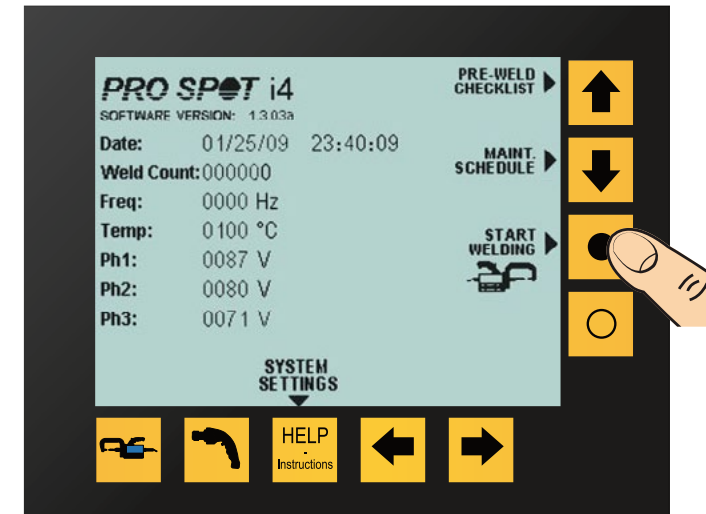

Figure 4.5a

After the welder has been turned on and when the pre-weld screen has appeared, press the "Start Welding" button (closed circle).



From this screen, enter the desired login. The i4 comes pre-programmed with the login user ID 0001, 0002, 0003, and 0004 available by default. After the correct ID is entered, press DONE to continue to the double-sided weld feature.



## 4.4 Choosing the weld mode



Figure 4.6

The i4 is a multi-functional resistance spot welder. It is equipped with a four weld cable system for your convenience. Two of the weld cables are connected to the Two-Sided Spot Gun and the other two are connected to the Single-Sided Weld Gun.

To select a weld mode, press the respective mode button (fig. 4.6)

Once the welding mode is selected, a group of related weld programs become available to the user (see section 4.8 "Setting the default weld programs")

## 4.5 Setting the pneumatic air pressure

Pneumatic air is used for:

- forcing the spot gun to close and open.
- cooling the welding cables that are connected to the spot gun.

The air pressure is regulated with the air regulator, and the set pressure is indicated on the pressure gauge. Default pressure is 90 PSI.

Change the air pressure as follows:

1. Unlock the pressure regulator by pulling on the adjustor knob till it snaps into the unlocked position.
2. Turn the pressure regulator knob clockwise to increase or counter-clockwise to decrease the air pressure.
3. Lock the pressure regulator by returning the knob to the lock position.

## 4.6 Setting/Changing the weld program



Figure 4.7

The i4 features 6 different strength weld power modes. It defaults to 0.7mm program. To change weld program press "Next Program" (fig. 4.7).

The program box indicates the weld power (thickness). For example, when welding two HSS Galv. metals that are 1.2mm thick, you should use the 1.2mm program.

If more power is desired, press "Next Program" to reach the next level.

**NOTE:** The Factory Password (1234) must be entered in order to modify weld programs. To enter the Factory Password press the Help button while booting at the third screen to access the System Settings menu. The text located near the Down Arrow button reads WELD SETTING CONTROL MODE: AUTO/MANUAL. Auto is selected by default. Press the Down Arrow button to enter Manual mode. In the PASSWORD REQUIRED pop up window enter 1234 using the arrow keys. Exit by pressing the Open Circle button. The welder is in manual mode and weld programs can now be modified.

## 4.7 Setting the weld time and current



Figure 4.8

The time and current automatically change with each respective weld power mode.

Referring to fig. 4.8: The top value indicates the time duration that will be applied during the weld and the bottom value indicates the weld power in weld amperage that will be applied during the weld.

## 4.8 Setting the default weld programs

There are 17 weld programs featured in the i4 Spot Welder. Ten of these programs are associated with the Single-Sided Gun and seven are associated with the Two-Sided Spot Gun.

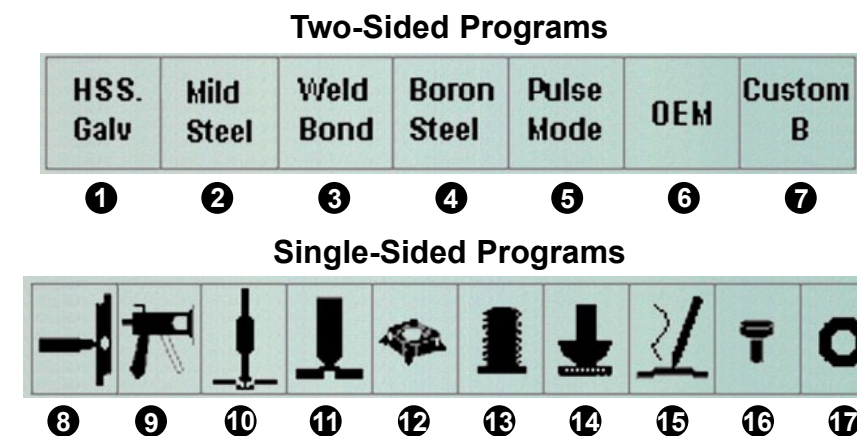

- |                                   |                        |
|-----------------------------------|------------------------|
| ① HSS Steel / Galv. Steel Welding | ⑩ Dent Pulling         |
| ② Mild Steel Welding              | ⑪ Contact Shrinking    |
| ③ Weld Bonding                    | ⑫ Nut Welding          |
| ④ Boron Steel Welding             | ⑬ Bolt Welding         |
| ⑤ Pulse Mode                      | ⑭ Stitch Welding       |
| ⑥ OEM-Specific Programs           | ⑮ Carbon Rod Shrinking |
| ⑦ Custom Program                  | ⑯ Rivet Welding        |
| ⑧ Single-Sided Spot Welding       | ⑰ Washer Welding       |
| ⑨ Pro Pull Dent Removal           |                        |

The welding programs are selected on the Control Panel. Select the welding program by using the Left and Right navigation buttons (fig. 4.9)

The selected program is indicated by a highlighted black box over the program name (fig. 4.10).

In any welding mode there are 6 power level programs: 0.7mm - 2.5mm. To switch between programs press the "Next Program" button (fig. 4.7).

Some programs require a double-weld in one cycle (fig. 4.11). Those welds automatically deliver Weld 1, programmed delay, then Weld 2. This is a very sophisticated weld feature for controlling exact temperature into the weld area and to pre-heat it.

**⚠ Note:** Two-Sided welding mode and Program No. 1 are set by default when the i4 is turned on.

**⚠ Note:** Mode recto- verso de soudage et le programme de soudage n° 1 sont définies par défaut lorsque le i4 est allumé.



Figure 4.9



Figure 4.10

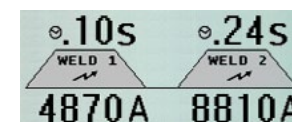

Figure 4.11

# 5 Double-Sided Welding

## 5.1 PS-500 Double-Acting Spot Gun

The spot gun is used for the following weld programs:  
• Two-Sided spot welding - HSS Galvanized steel, Mild steel, Weld Bonding, Boron Steel, Pulse welding and OEM, Custom Modes

(see section 4.8 "Setting the default welding programs")

### 5.1.1 PS-500 Component Diagram

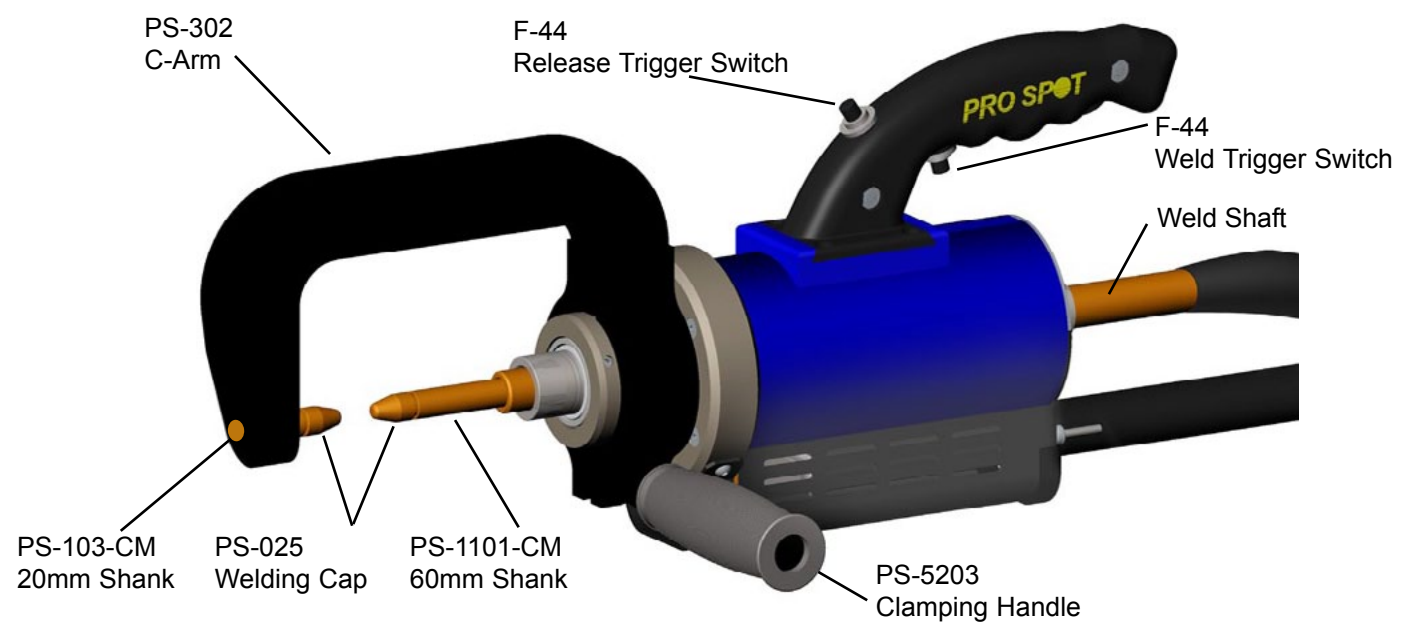
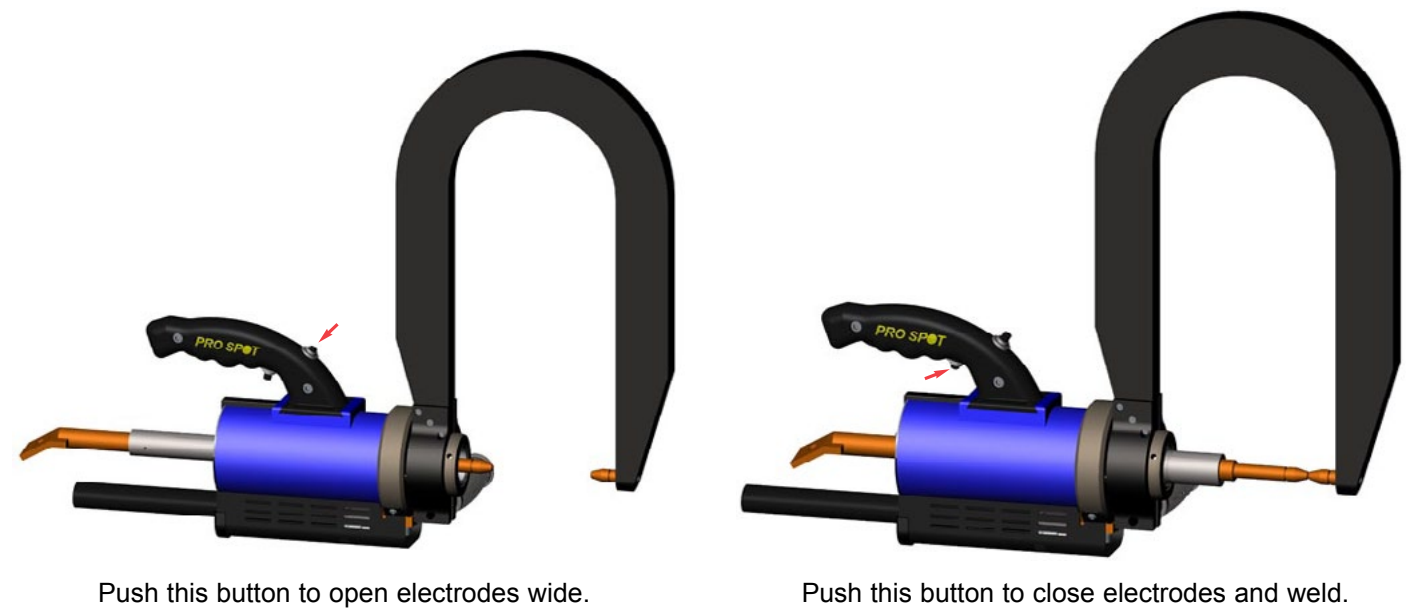

Figure 5.1 PS-500 Spot Gun - Component Diagram

### 5.1.2 Using the Double-Acting Gun



Push this button to open electrodes wide.

Push this button to close electrodes and weld.

## 5.2 Extension Arms

The Pro Spot i4 comes with a variety of extension arms to accomodate any welding job situation.

Please refer to fig. 5.3 for details on what welding electrodes to use with each extension arm.

**NOTE:** Extension arms marked "optional" are available from your local distributor or online at [www.prospot.com](http://www.prospot.com)

**REMARQUE:** bras d'extension portant la mention «facultatif» sont disponibles à partir de votre Distributeur régional ou en ligne à [www.prospot.com](http://www.prospot.com)

Figure 5.2 i4 Extension Arms



### 5.2.1 Switching to extension arms

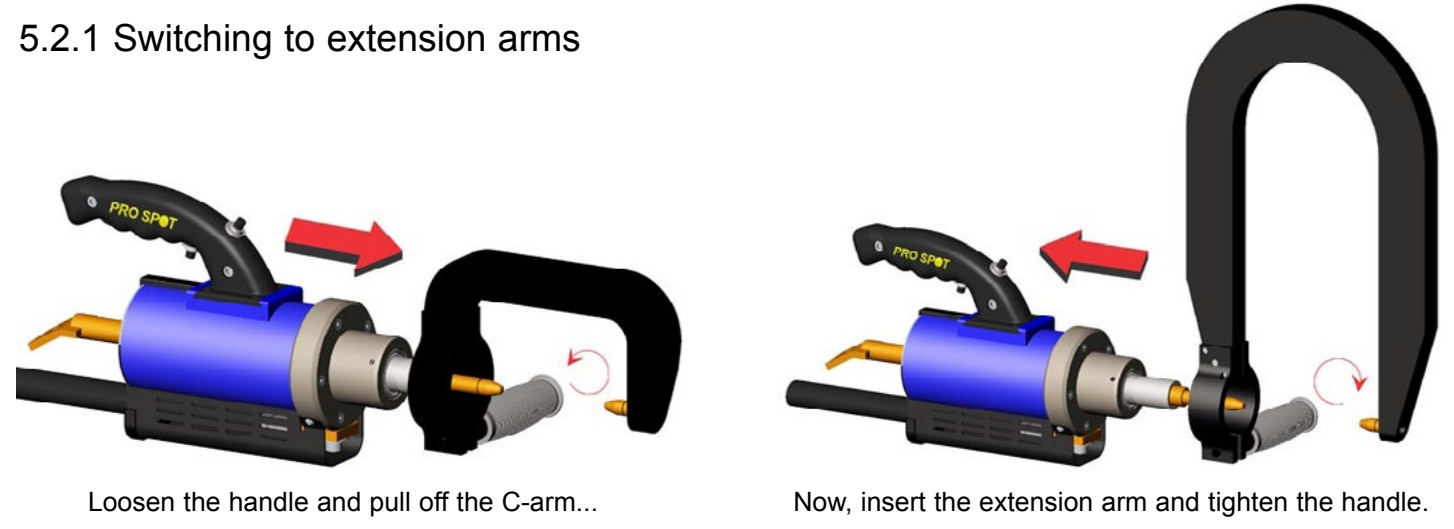

Loosen the handle and pull off the C-arm...

Now, insert the extension arm and tighten the handle.

### 5.2.2 Extension Arms and Welding Electrodes

Different extension arms require the use of different welding electrodes. Use charts in fig. 5.3 and 5.4 to determine the correct combination of extension arms and welding electrodes.

**IMPORTANT!** Using incorrect welding electrodes with extension arms may result in weak welds and/or damage to your welder.

**IMPORTANT!** En utilisant des électrodes de soudage inexactes au bras d'extension peut donner des soudures faibles et / ou endommager votre soudeur.

|           | A              | B              | C |
|-----------|----------------|----------------|---|
| PS-302    | PS-1101-CM     | PS-103-CM      |   |
| PS-52-5/8 | PS-1101-CM     | PS-1133-5/8    |   |
| PS-403    | see Sec. 5.7.3 | see Sec. 5.7.3 |   |
| PS-305    | PS-1101-CM     | PS-129-CM      |   |
| PS-503-W  | PS-1101-CM     | PS-128-CM      |   |

Figure 5.3 Extension arm - Welding electrode configuration chart



| Electrode Shank | PS-025: Welding Cap |
|-----------------|---------------------|
| PS-103-CM       | 40 mm*              |
| PS-102-CM       | 60 mm*              |
| PS-1101-CM      | 80 mm*              |
| PS-128-CM       | 100 mm*             |
| PS-129-CM       | 120 mm*             |
| PS-130-CM       | 160 mm*             |

\* length with Welding Cap attached. -20mm w/o cap

Figure 5.4 Welding electrode selection chart

**NOTE:** PS-025 Welding Caps can be purchased in packages of 15 from your local distributor or online at [www.prospot.com](http://www.prospot.com)

**REMARQUE:** PS-025 caps de soudure peuvent être achetés en paquets de 15 à partir de votre distributeur local ou en ligne à [www.prospot.com](http://www.prospot.com)

### 5.3 PS-500 Electrode Alignment

Use the set screws (A, B, C) to align the electrodes. Ex: to move electrode down, loosen screw (C) and tighten screws (A and B).

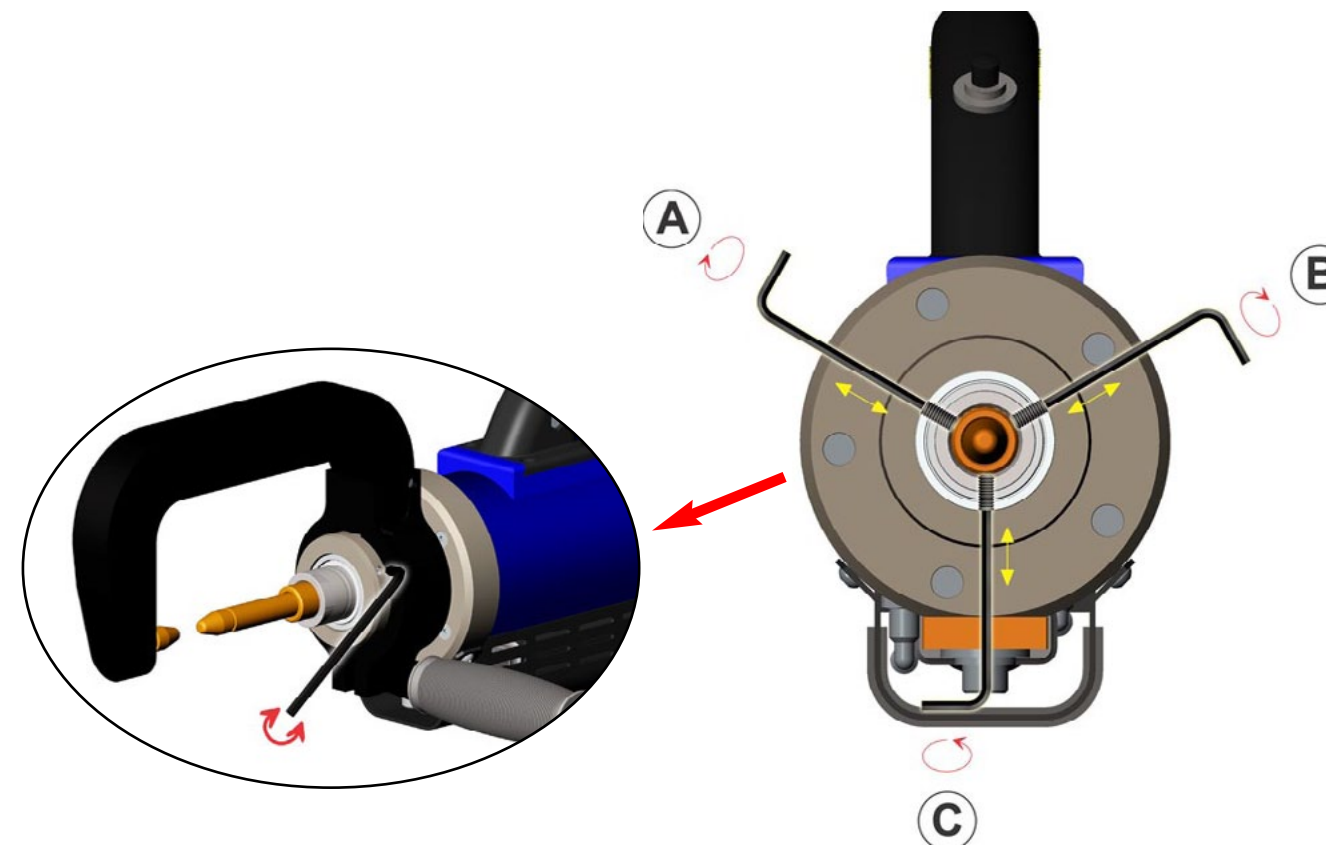
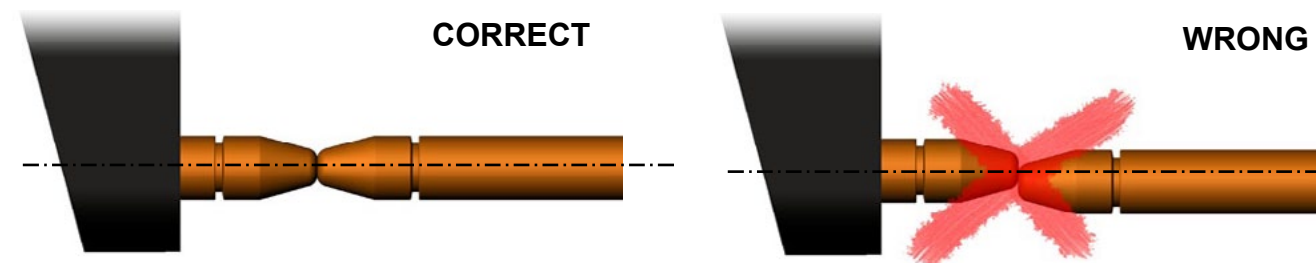

Figure 5.5 Electrode Alignment



**IMPORTANT!** Always maintain proper electrode alignment. Not doing so may result in weak, substandard welds!

**IMPORTANT!** Toujours maintenir l'alignement des électrodes appropriées. Ne pas le faire peut conduire aux soudures faibles de qualité inférieure!

## 5.4 Removing Welding Electrodes



Figure 5.6a: Removing Piston Electrode



Figure 5.6b: Removing Welding Cap

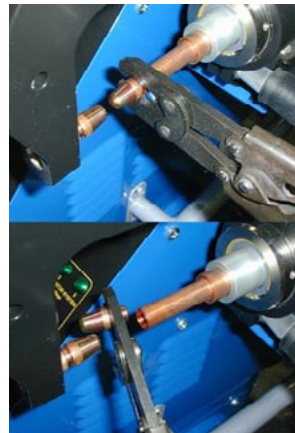

Figure 5.6c: Optional Weld Cap Removal Tool

### Removing Extension Arm Electrode

The extension arm electrodes can be easily removed by lightly tapping them with a pin and hammer as shown in *fig. 5.6*

To remove the piston electrode:

1. Grip piston electrode with a set of pliers or vise-grips (*fig. 5.6a*).
2. Rock the pliers back and forth to loosen the electrode from the holder.
3. Remove the electrode

**Note:** Vise-Grips shown in *fig. 5.6a* are specially designed to hold round objects without damaging or scarring them. You can purchase a set from your local distributor or online at: [www.prospot.com](http://www.prospot.com)

**IMPORTANT!** Do not attempt to remove the electrode by hitting it. This could damage the electrode and the spot gun.

**IMPORTANT!** N'essayez pas de retirer l'électrode en la frappant. Cela pourrait endommager l'électrode et le "pistolet".

### Removing Welding Caps

To remove a welding cap:

1. Hold piston electrode with a set of pliers or vise-grips.
2. Grip welding cap with another set of pliers or wedge side cutters between cap and shank as shown in *fig. 5.6b*
3. Twist the two to loosen and remove the welding cap.

**NOTE:** An optional welding electrode cap removal tool is available, which makes cap removal easy (*fig. 5.6c*). You can order the cap removal tool from your local distributor or online at: [www.prospot.com](http://www.prospot.com)

**NOTE:** Une option d'un outil pour enlever le bouchon est disponible, Pour faciliter le retrait du bouchon (*fig. 5.6c*). Vous pouvez commander cet outil de votre distributeur local ou en ligne à l'adresse: [www.prospot.com](http://www.prospot.com)

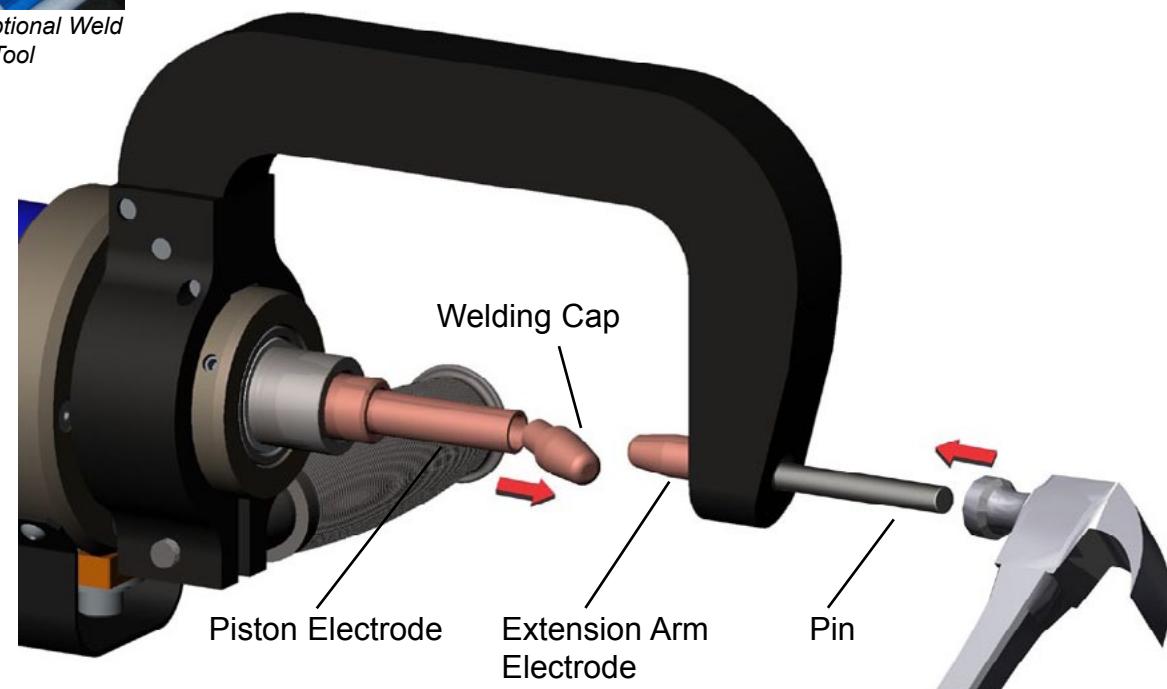

Figure 5.6 Removing Welding Electrodes

## 5.5 Welding Electrode Maintenance

To maintain structurally-sound welds it is important to keep your welding electrodes clear from build-up. It is also important to maintain a 6mm weld nugget diameter. Clean electrodes with a file and periodically replace welding caps as explained in Section 5.4 "Removing Welding Electrodes"

**WARNING!** The electrodes may be hot. Use caution when handling them.

**ATTENTION!** Les électrodes peuvent être chauds. Soyez prudent lors de leur manipulation.

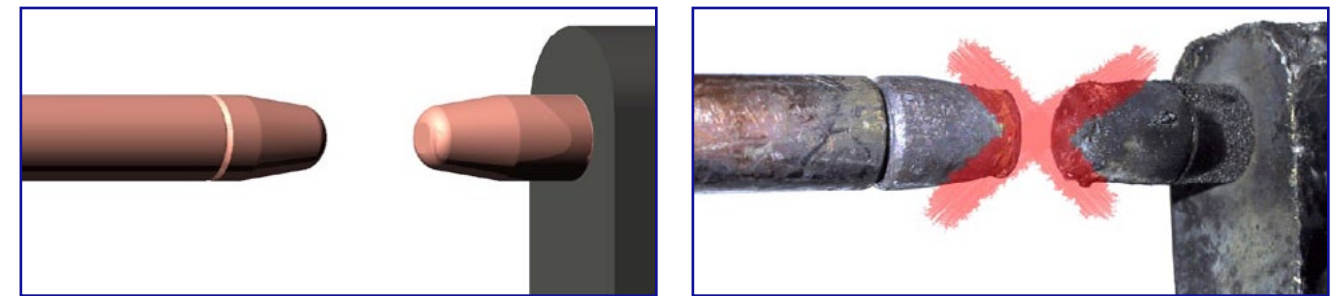

### 5.6 Wheel House Arm

The wheel house adapter allows access to hard to reach areas such as the wheel house

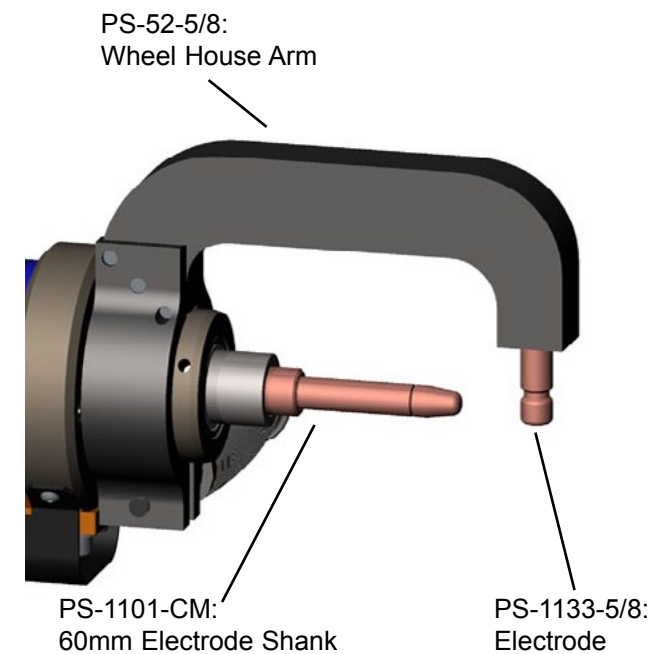

### 5.7 X-Adapter (optional)



#### C-TYPE GUN

The advantage of the C-Type Spot Gun is that when making vertical pinch welds on quarter panels, rocker panels, door pillars, etc., the spot gun is positioned perpendicular to the work area. Easy to reach! Easy to use!



#### X-TYPE GUN

The X-type design is used on certain applications where the C-type can't reach. 90% of all welding needs can be done with the C-type but for some radiator support and truck bed pinch welds, the X-Adapter works better. This new invention from Pro Spot makes it possible to weld where you never could before!

### 5.7.1 Attaching the X-Adapter



1 Loosen the handle and pull out C-arm...

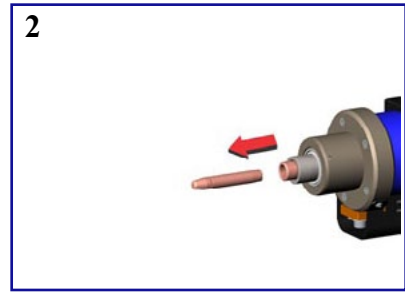

2 Follow instructions in **Sec. 5.4** to remove piston electrode

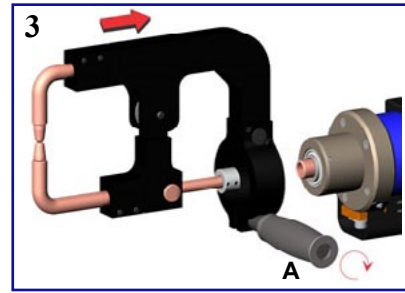

3 Insert the X-Adapter onto the gun. Tighten handle (A).

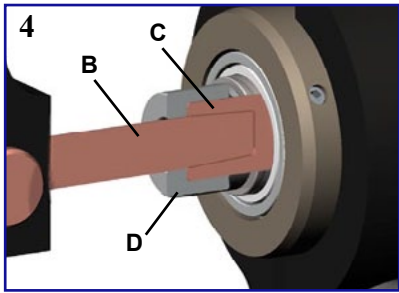

4 Insert the Tapered Electrode (B) into the Shaft (C). Apply air (carefully) to put pressure on the electrodes so that Tapered Electrode seats firmly in the shaft before tightening the Collar (D) set screw.

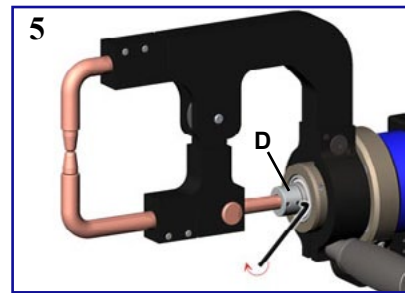

5 Tighten the Collar (D) set screw.

**IMPORTANT!** Do not tighten the Collar before the inserting Tapered Electrode into the shaft. The collar is designed to prevent the Tapered Electrode from falling out of the Shaft when the gun is fully opened.

**IMPORTANT!** Ne serrez pas le collier avant de glisser l'Électrode Rétréci dans le tube. Le collier est conçu pour empêcher l'Électrode Rétréci de tomber du tube quand le pistolet est complètement ouvert.

### 5.7 X-Adapter (optional) cont.

### 5.7.2 Using the X-Adapter



Push the upper switch to open electrodes wide.

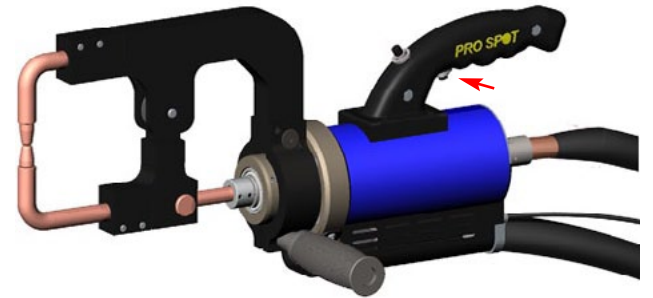

Push the lower switch to close electrodes and weld.

### 5.7.3 X-Adapter Configurations

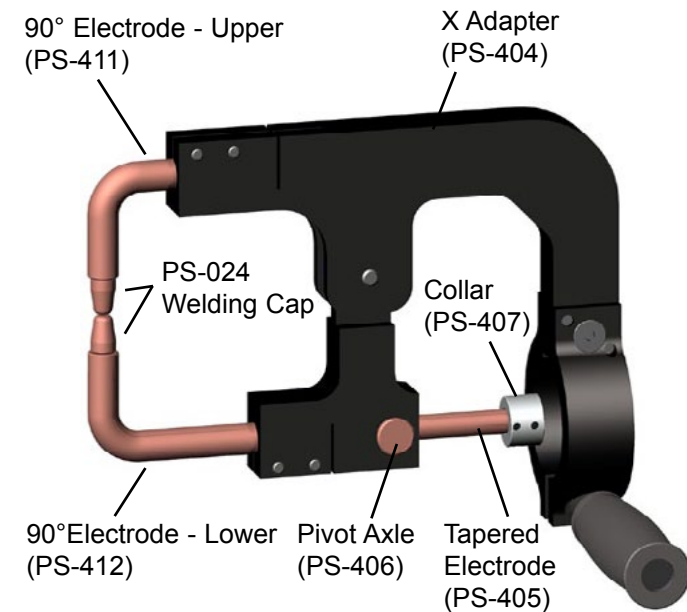

Figure 5.7 90° Arm Set

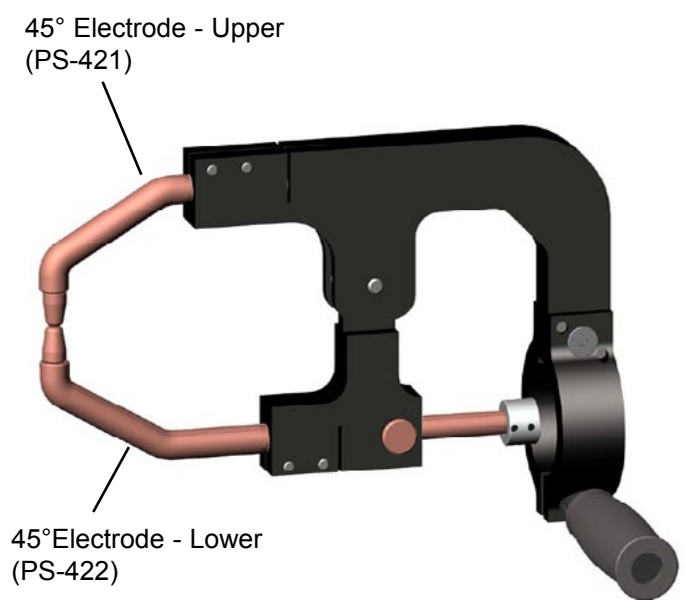

Figure 5.8 45° Arm Set

## 6 Single-Sided Welding

### 6.1 Single-Sided Welding Overview

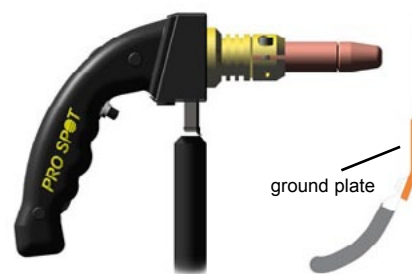

Figure 6.1

The Single-Sided Weld System allows the operator to carry out welding tasks using a Single-Sided Weld Gun. The Single-Sided weld procedure requires contact only from one side compared to two sides in Two-Sided welding. A ground plate must be connected to the panel to be welded for it to work (fig. 6.1).

You can also use an optional magnetic ground plate to easily attach the ground cable to the metal (fig. 6.1b).



**NOTE:** Make sure the ground plate is clamped firmly in place on the inside of a clean metal surface as near as possible to the weld location. Do not attach the ground to the metal you're about to weld on. When performing other weld tasks such as dent pulling, etc., the ground attachment location becomes less critical.



**REMARQUE:** Assurez-vous que la plaque de terre est serré solidement en place à l'intérieur d'une surface métallique propre aussi près que possible du lieu de soudure. Ne fixez pas le terre et le métal que vous êtes sur le point de soudure. En accomplissant d'autres tâches comme la soudure dent de traction, etc, le lieu de saisie devient moins critique.

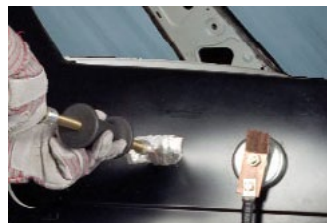

Figure 6.1b

In the Single-Sided weld mode the following weld procedures are available for the i4:

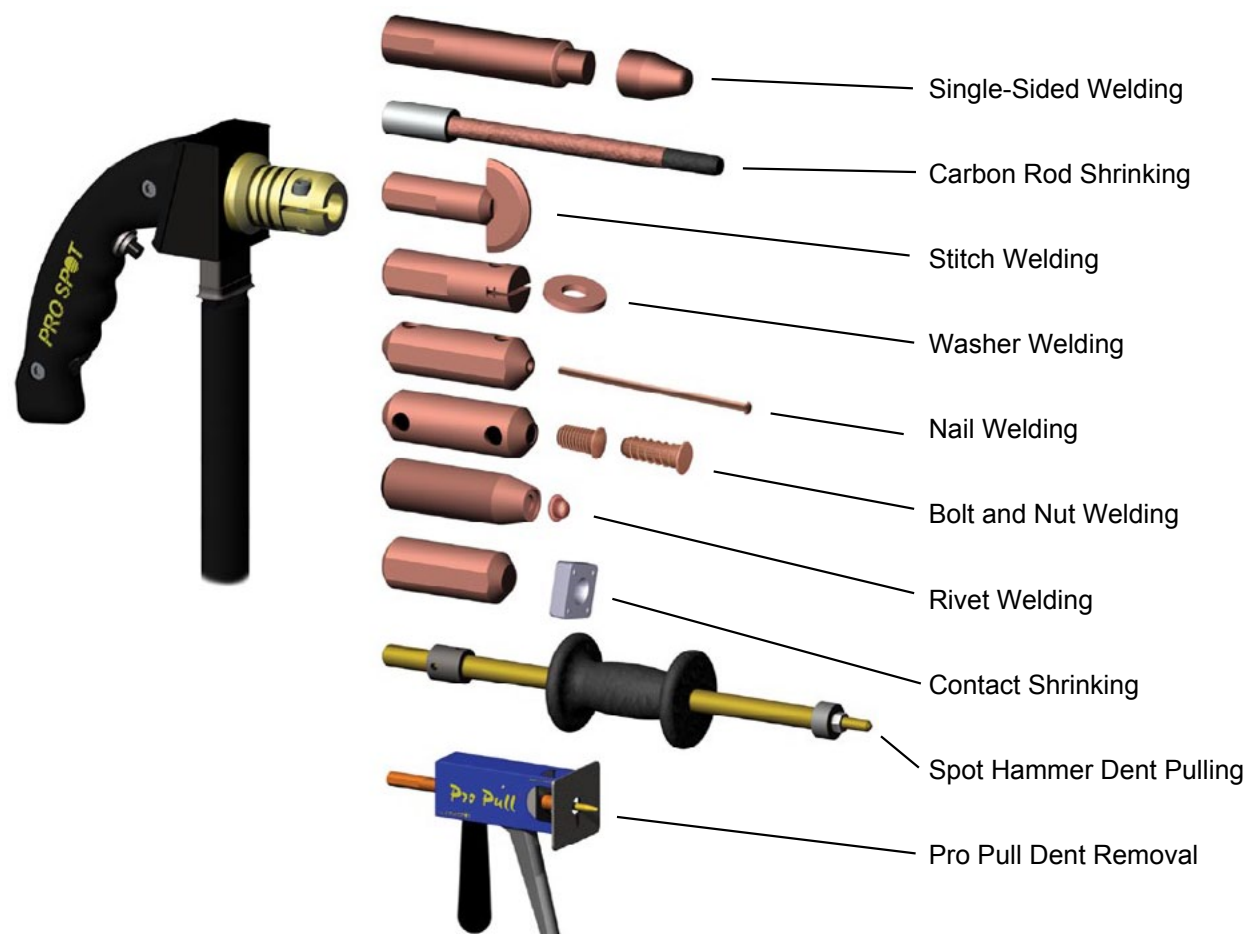

Figure 6.2 Single-Sided applications



Figure 6.3: Selecting Single -Sided weld mode

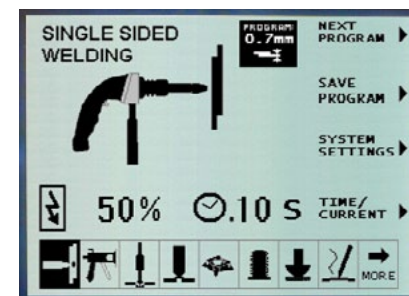

Figure 6.4

1. Make sure the welder is turned on. Push the Single-Sided weld mode button (fig 6.3). Single Sided Weld Programs will display on the screen (fig. 6.5).

2. Use the navigation buttons, Left or Right to select desired weld program (refer to section 4.8 "Setting the default weld program" or fig.4.9). The display screen shows the currently selected program (fig. 6.4).

#### Single-Sided Programs

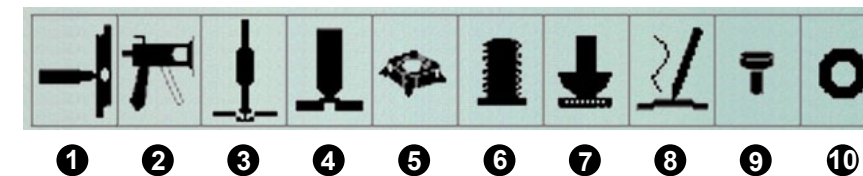

Figure 6.5 i4 Single Sided Weld Programs

- 1 Single-Sided spot welding
- 2 Pro Pull Dent Removal
- 3 Dent Pulling
- 4 Contact Shrinking
- 5 Nut Welding
- 6 Bolt Welding
- 7 Stitch Welding
- 8 Carbon Rod Shrinking
- 9 Rivet Welding
- 10 Washer Welding

## 6.2 Single-Sided Spot Welding



Figure 6.6

Single-Sided spot welding is used where Two-Sided spot welding cannot be used.

**Important:** The Single-Sided spot welding is not permitted on supporting frameworks of a vehicle. It is only permitted for cosmetic purposes.

**Important:** Le soudage de Côté Unique par points n'est pas autorisée sur les cadres de soutien d'un véhicule. Il est seulement permis à des fins cosmétiques.



Figure 6.9

1. Push the Single-Sided weld mode button (fig 6.3). Single Sided Weld Programs will display on the screen (fig. 6.5). The i4 software defaults to Single Spot Weld Mode (fig. 6.6).
2. Choose weld power level by pressing the "Next Program" button repeatedly. (refer to section 4.6 "Setting the weld program").
3. Fit the Single-Sided Gun with Single-Sided electrode (fig. 6.9).
4. Grind between the inner and the outer body sheets to remove paint, primer and rust. This ensures good electrical contact when performing Single-Sided welding.
5. Ground the working area (refer to section 6.1 "Single-Sided Welding Overview").
6. Apply about 33-44 lbs of pressure on the Single-Sided gun and push the trigger to weld. Reposition and weld again.

**Note:** Make sure that Single-Sided electrode is clean. If it isn't, use a file or tip dresser to clean it. If the weld cap shows considerable wear, it should be replaced (refer to section 5.4 "Removing Welding Electrodes")

**Remarque:** Assurez-vous que l'électrode Côté Unique est propre. Si ce n'est pas, utilisez une lime pour le nettoyer. Si le bouchon de soudure est considérablement usé, il devrait être remplacé (voir la section 5.4 "Enlèvement d'Electrodes de soudage")

## 6.3 Bolt Welding

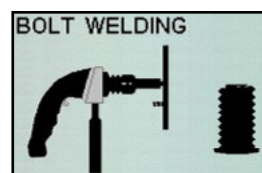

Figure 6.10

Many of today's car bodies come with factory equipped threaded studs. After a collision, the studs may be lost or do not accompany the replacement part. With the i4, threaded studs can be welded-on in factory style. This type of stud is also common throughout the car body for attachments of interior, tail lights, door moldings, etc.

**Tip:** A threaded stud can also be used to fasten the ground clamp directly to the panel, minimizing the area needed for grinding.

**Astuce:** Un goujon fileté peut également être utilisé pour fixer la pince directement sur le panneau, ce qui réduit la surface nécessaire au broyage.



Figure 6.12

Studs are held in place during welding with magnetic adapter electrode.

1. Push the Single-Sided weld mode button (fig 6.3). Single Sided Weld Programs will display on the screen (fig. 6.5). The i4 software defaults to Single Spot Weld Mode (fig. 6.6).
2. Select Bolt Welding Program by pressing the Left or Right Navigation Buttons (fig. 4.9). Make sure that Bolt Welding graphic appears on the screen (fig. 6.10)
3. Choose weld power level by pressing the "Next Program" button repeatedly. (refer to section 4.6 "Setting the weld program").
4. Fit Single Sided gun with the magnetic stud adapter (fig. 6.12).
5. Insert stud into the adapter (fig. 6.12).
6. Prepare the surface area by removing paint and primer.
7. Ground the working area (refer to section 6.1 "Single-Sided Welding Overview").
8. Position single sided gun over work area and push the trigger to weld.
9. Repeat as needed.

## 6.4 Nut Welding

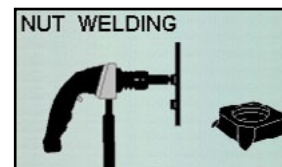

Figure 6.13

Weld-on nuts are common throughout the car body for attachments of interior, tail lights, door moldings, etc. and are applied with ease using the i4.

**Tip:** Different size nuts are available from your local Pro Spot distributor or on the web at Pro Spot online store.

**Astuce:** noix de différentes tailles sont disponibles chez votre distributeur local Spot Pro ou sur le web à la boutique Pro Spot en ligne.



Figure 6.15

Nuts are held in place during welding with a shrinking electrode.

1. Push the Single-Sided weld mode button (fig 6.3). Single Sided Weld Programs will display on the screen (fig. 6.5). The i4 software defaults to Single Spot Weld Mode (fig. 6.6).
2. Select Nut Welding Program by pressing the Left or Right Navigation Buttons (fig. 4.9). Make sure that Nut Welding graphic appears on the screen (fig. 6.13)
3. Choose weld power level by pressing the "Next Program" button repeatedly. (refer to section 4.6 "Setting the weld program").
4. Fit Single-Sided gun with the Shrink Electrode (fig. 6.15).
5. Prepare the surface area by removing paint and primer.
6. Ground the working area (refer to section 6.1 "Single-Sided Welding Overview").
7. Press weld-on nut to the metal with Contact Shrinking electrode, apply some pressure and push the trigger to weld.
8. Repeat as needed.

## 6.5 Dent Pulling with Spot Hammer



Figure 6.16

Spot hammer dent pulling is used to repair dents on a vehicle body. The spot hammer welds directly onto the work area and pulls the dent.

**Tip:** The replaceable welding tip should last for over one thousand welds. Contact your local distributor to order replacement tips, or order on the web at Pro Spot online store.

**Astuce:** Le bout de soudage remplaçable devrait durer plus d'un millier de soudures. Contactez votre distributeur local pour commander pointes de rechange, ou commandez sur la Web Pro Spot au magasin en ligne.

1. Push the Single-Sided weld mode button (fig 6.3). Single Sided Weld Programs will display on the screen (fig. 6.5). The i4 software defaults to Single Spot Weld Mode (fig. 6.6).
2. Select Spot Hammer Program by pressing the Left or Right Navigation Buttons (fig. 4.9). Make sure that Spot Hammer graphic appears on the screen (fig. 6.16)
3. Choose weld power level by pressing the "Next Program" button repeatedly. (refer to section 4.6 "Setting the weld program").
4. Fit Single-Sided gun with the spot hammer (fig. 6.18).
5. Prepare the dent surface area by removing paint and primer.
6. Ground the working area (refer to section 6.1 "Single-Sided Welding Overview").
7. Position the spot hammer tip at the bottom of the dent and push the trigger to weld the electrode onto the metal.
8. Pull out a dent then release by twisting the hammer.
9. If needed, reposition, weld, and pull again.

When more pulling power is needed, simply increase the current.

**Note:** Check spot hammer tip periodically to make sure it is in good working order. If the tip looks worn, replace it with a new one.

**Note:** Contrôlez le bout marteau périodiquement pour s'assurer qu'il est en bon état de marche. Si le bout semble usé, le remplacer par un nouveau.

## 6.6 Moulding Clip Rivet Welding

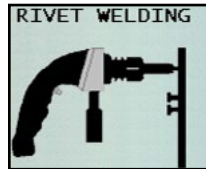

Figure 6.19



Figure 6.21

This function will weld on factory type clips for the window moulding. The clips that hold the moulding do not, usually, come on the replacement parts.

Rivets are held in place during welding with magnetic adapter electrode.

1. Push the Single-Sided weld mode button (fig 6.3). Single Sided Weld Programs will display on the screen (fig. 6.5). The i4 software defaults to Single Spot Weld Mode (fig. 6.6).
2. Select Rivet Welding Program by pressing the Left or Right Navigation Buttons (fig. 4.9). Make sure that Rivet Welding graphic appears on the screen (fig. 6.19)
3. Choose weld power level by pressing the "Next Program" button repeatedly. (refer to section 4.6 "Setting the weld program").
3. Fit Single-Sided gun with the magnetic rivet adapter (fig. 6.21).
4. Insert rivet into the adapter (fig. 6.21).
5. Prepare the surface area by removing paint and primer.
6. Ground the working area (refer to section 6.1 "Single-Sided Welding Overview").
7. Position Single-Sided gun over work area and push the trigger to weld.
8. Repeat as needed.

## 6.7 Dent Pulling with Washers and Slide Hammer with Hook



Figure 6.22

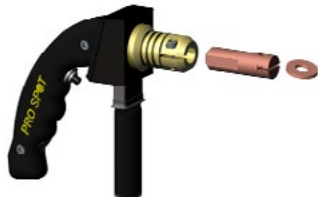

Figure 6.24

The slide hammer with hook (optional) can be used in conjunction with washers to repair car body dents.



**Tip:** You can purchase a slide hammer with hook from your local Pro Spot distributor or on the web at Pro Spot online store.



**Astuce:** Vous pouvez acheter un marteau glissant avec crochet de votre distributeur locale Pro Spot ou sur le web à la boutique Pro Spot en ligne.

Washers are held in place during welding with magnetic adapter electrode.

1. Push the Single-Sided weld mode button (fig 6.3). Single Sided Weld Programs will display on the screen (fig. 6.5). The i4 software defaults to Single Spot Weld Mode (fig. 6.6).
2. Select Washer Welding Program by pressing the Left or Right Navigation Buttons (fig. 4.9). Make sure that Washer Welding graphic appears on the screen (fig. 6.22)
3. Choose weld power level by pressing the "Next Program" button repeatedly. (refer to section 4.6 "Setting the weld program").
4. Fit Single-Sided gun with the magnetic washer adapter (fig. 6.24).
5. Insert washer into the adapter (fig. 6.24).
6. Prepare the dent surface area by removing paint and primer. When welding on washers, you only need to clean the area where the washer touches the metal since the grounding system is connected through a separate cable.
7. Ground the working area (refer to section 6.1 "Single-Sided Welding Overview").
8. Position the washer at the bottom of the dent and push the trigger to weld the washer onto the metal.
9. Hook the washer with the slide hammer and pull out the dent.
10. Repeat as needed.



**Tip:** You can, also, pull multiple washers by welding on a row of washers at the bottom of the dent, inserting a rod through the washers and pulling the rod with the slide hammer with hook.



**Astuce:** Vous pouvez, également, tirer plusieurs rondelles par soudage sur une rangée de rondelles au bas de la Dent, insertant une baguette par les rondelles et en tirant la tige avec le marteau glissant avec crochet.

## 6.8 Contact Shrinking



Figure 6.25



Figure 6.27

Dent pulling with washers creates high spots in the metal. Until now, the common practice would have been to grind the surface, resulting in a loss of sheet metal thickness. With the i4, use the shrinking tip instead of a grinder to remove the high spots, leaving a smooth and clean surface that's every bit as thick and strong as before. Shrinking electrode also acts as a nut adapter (refer to section 6.4 "Nut Welding"). With this electrode you get two convenient tools in one.

1. Push the Single-Sided weld mode button (fig 6.3). Single Sided Weld Programs will display on the screen (fig. 6.5). The i4 software defaults to Single Spot Weld Mode (fig. 6.6).
2. Select Contact Shrinking Program by pressing the Left or Right Navigation Buttons (fig. 4.9). Make sure that Contact Shrinking graphic appears on the screen (fig. 6.25)
3. Choose weld power level by pressing the "Next Program" button repeatedly. (refer to section 4.6 "Setting the weld program").
4. Fit Single-Sided gun with the contact shrinking electrode (fig. 6.27).
5. Prepare the surface area by removing paint and primer.
6. Ground the working area (refer to section 6.1 "Single-Sided Welding Overview").
7. Position the contact shrinking electrode over the high spot, apply some pressure and push the trigger to weld.
8. Repeat as needed.

## 6.9 Carbon Rod Shrinking / Stretching



Figure 6.28



Figure 6.30

Carbon Rod is used to shrink or stretch metal on a vehicle. The carbon rod can also be used on sharp dents caused by such things as hail.

1. Push the Single-Sided weld mode button (fig 6.3). Single Sided Weld Programs will display on the screen (fig. 6.5). The i4 software defaults to Single Spot Weld Mode (fig. 6.6).
2. Select Carbon Shrink Program by pressing the Left or Right Navigation Buttons (fig. 4.9). Make sure that Carbon Shrink graphic appears on the screen (fig. 6.28)
3. Choose weld power level by pressing the "Next Program" button repeatedly. (refer to section 4.6 "Setting the weld program").
4. Fit the Single-Sided Gun with Carbon Electrode (fig. 6.30).
5. Clean the metal surface area.
6. Ground the working area (refer to section 6.1 "Single-Sided Welding Overview").
7. Position carbon rod over the work area and push the trigger to start welding. Keep trigger depressed to continue welding. Move the carbon rod in such a way as to heat up the entire working area to the appropriate temperature. Release the trigger to stop welding.
8. Cool the surface with a wet rag or compressed air.



## 6.10 Stitch Welding



Figure 6.31

The i4 can also be fitted with a stitch weld adapter enabling the operator to lay staggered bead type welds. While rolling the tip on the sheet metal edge, the welder will automatically deliver an intermittent or pulsating current.

1. Push the Single-Sided weld mode button (fig 6.3). Single Sided Weld Programs will display on the screen (fig. 6.5). The i4 software defaults to Single Spot Weld Mode (fig. 6.6).
2. Select Stitch Welding Program by pressing the Left or Right Navigation Buttons (fig. 4.9). Make sure that Stitch Welding graphic appears on the screen (fig. 6.31)
3. Choose weld power level by pressing the "Next Program" button repeatedly. (refer to section 4.6 "Setting the weld program").
4. Fit Single-Sided gun with the stitch electrode (fig. 6.33).
5. Prepare the surface area by removing paint and primer.
6. Ground the working area (refer to section 6.1 "Single-Sided Welding Overview").
7. Roll the tip on the sheet metal edge while keeping the trigger depressed. The welder will automatically deliver an intermittent or pulsating current.
8. Repeat as needed.



Figure 6.33

This procedure works well on stainless steel, and therefore lends itself well to rust repair and patching. It's easy to use and can be manipulated to fit any shape or form you require.



**Tip:** You can use stitch electrode to weld pulling tabs onto areas that need to be pulled.



**Astuce:** vous pouvez utiliser l'électrode de point à souder tirant des onglets sur des endroits qui ont besoin d'être tirés.

## 6.11 Pro Pull Dent Pulling (optional)

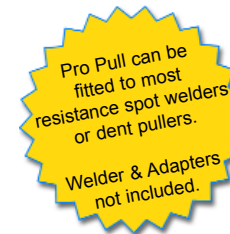

Pro Pull is a patented, innovative tool for fast and accurate dent pulling. It features paintless dent removal functionality (see sec. 6.3.5 "Paintless Dent Pulling With Pro Pull").

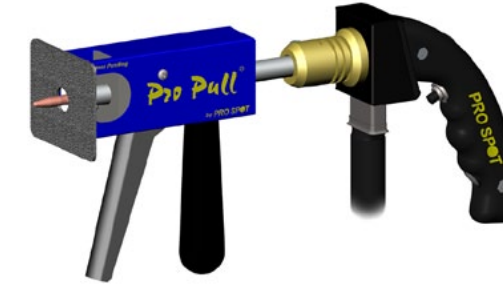

### 6.11.1 Selecting Pro Pull Weld Mode

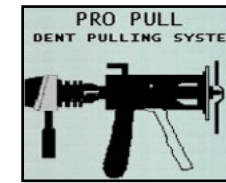

Figure 6.6 Selecting Pro Pull weld mode

1. Push the Single-Sided weld mode button (fig 6.3). Single Sided Weld Programs will display on the screen (fig. 6.5). The i4 software defaults to Single Spot Weld Mode (fig. 6.6).
2. Select Pro Pull Welding Program by pressing the Left or Right Navigation Buttons (fig. 4.9). Make sure that Pro Pull Welding graphic appears on the screen (fig. 6.6).



Make sure the ground plate is clamped firmly in place on the inside of a clean metal surface as near as possible to the weld location.

**NOTE:** Do not attach the ground to the metal you're about to weld on. When performing other weld tasks such as dent pulling, etc., the ground attachment location becomes less critical.



Assurez-vous que la plaque de terre est serré fermement en place à l'intérieur d'une surface propre de métal le plus près que possible au lieu de soudure.

**NOTE:** Ne fixez pas le terre et le métal que vous êtes sur le point de souder. Lors de l'exécution d'autres tâches comme la soudure dent de traction, etc, le terre du lieu de saisie devient moins critique.

### 6.11.2 Pro Pull Component Diagram

Pro Pull comes with three different Blocking Plates with Quick-Connect design.

Block window size:  
2.5" (63mm) x 1.5" (38mm)

PP-10-04

Block window size:  
1.75" (44mm) x 1" (25mm)

PP-10-03

Block window size:  
0.75" (19mm) dia.

PP-10-01

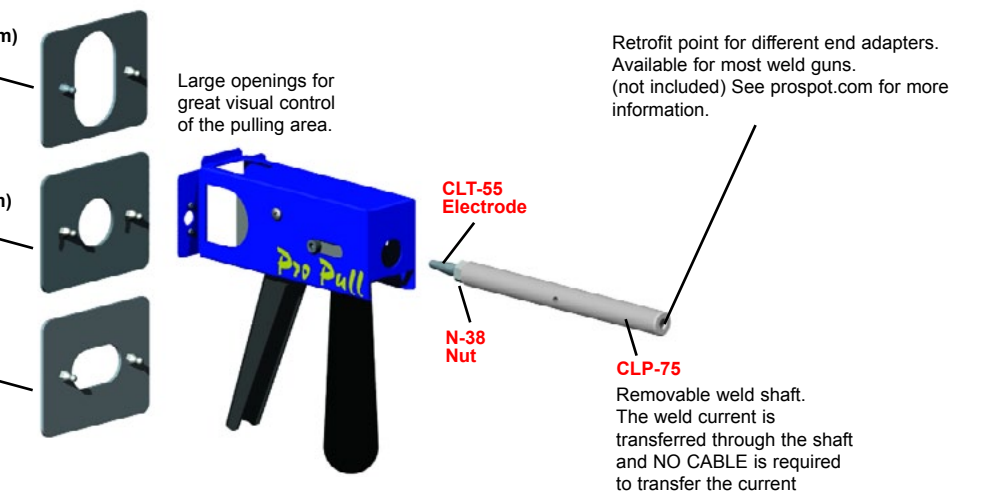

### 6.11.3 Pro Pull Assembly

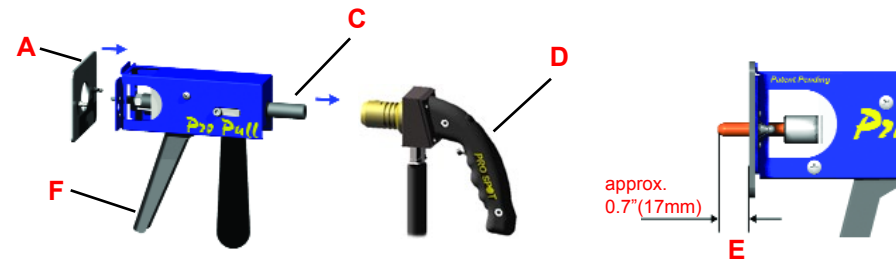

1. Attach the Weld Gun (D) to Weld Shaft (C). Secure Lock Bolt (G).
2. Slide weld shaft and gun to standard distance (E).
3. Attach desired block plate (A)
4. Position the weld tip in the "bottom" of the dent, weld, then pull the handle (F) to initiate the pulling action. Use the shortest weld TIME possible to prevent extensive weld marks.

### 6.11.4 Dent Pulling with Pro Pull



### 6.11.5 Paintless Dent Pulling With Pro Pull



## 7 i4 Login Feature

### 7.1 Overview

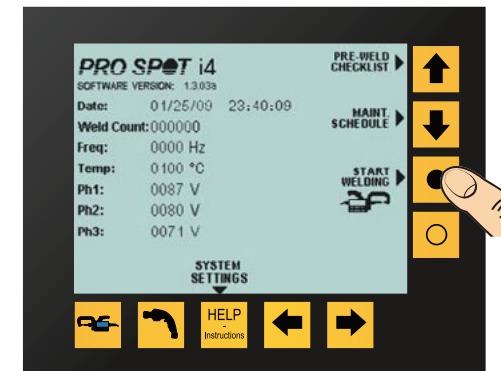

After the welder has been turned on and when the pre-weld screen has appeared, press the "Start Welding" button (closed circle).

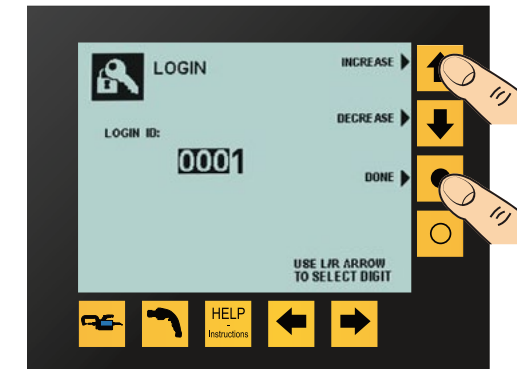

From this screen, enter the desired login. The i4 comes pre-programmed with the login user ID 0001, 0002, 0003, and 0004 available by default. After the correct ID is entered, press DONE to continue to the double-sided weld feature.

1. The i4 software (versions 1.3.03 and up) utilizes three levels of access: a Factory Password, Login Master Password, and Login User Passwords.

Login Master Password: 2625

Login User Password: Selectable between 0001-9999

2. Only the Login Master Account has access to the Technician password configuration menu. There are 20 passwords arranged in a 5x4 matrix with initial values of 0001. The displayed 0001 represents an active password. Selecting any other number (0001 – 9999) will activate it. The Login Master Password can activate up to 20 Login User Passwords.

### 7.2 Turning the Login Function Off

3. After startup, press 'Start Welding' at the first Status screen (closed circle button).
4. Login with the Manager Account when prompted (2625).
5. Scroll to Custom B in the Double Sided weld menu. Press System Settings (closed circle button) and you will arrive in the Login menu. From here we can turn the Login off by pressing LOGIN ON/OFF (closed circle button). The software will reboot with the preferences stored.

### 7.3 Turning the Login Function On

6. When we turn the i4 on it will not prompt for any User password if the Login function is turned off.
7. To turn the Login function on, we have to enter the Factory Password (1234) while booting.
8. Push the Help button while booting at the third screen to access the System Settings menu. The text located near the Down Arrow button reads WELD SETTING CONTROL MODE: AUTO/MANUAL. Auto is selected by default. Press the Down Arrow button to enter the Manual mode. In the PASSWORD REQUIRED pop up window enter 1234 using the arrow keys. Exit by pressing the Open Circle button.
9. In the System Settings menu press Exit (open circle button). The software will reboot and arrive at the first Status screen. Press the Start Welding button (closed circle) and you will access the weld menu without being prompted for a User password (Login function is still off).
10. Scroll to Custom B in the Double Sided weld menu. Press System Settings (closed circle button) and you will arrive in the Login menu. From here we can turn the Login on by pressing LOGIN ON/OFF (closed circle button). The software will reboot with the preferences stored.

## 7 i4 Login Feature

### 7.4 Switching Passwords

11. Here we will explain how to switch to another Login User Password without powering the i4 down (on the fly).
12. While the i4 is running, make sure the Login function is on, and the Login User password is set to 0001.
13. Scroll to Custom B in the Double Sided weld menu. Press System Settings (closed circle button) and you will arrive in the Login menu. Press "Change" (up arrow button) to enter a new password.
14. Enter the desired existing Login Password (ex: 0002).
15. If we enter a wrong number and press Done, a "WARNING! Invalid login ID Try Again" error message window will appear.

**NOTE:** It is important that a valid password is entered or the machine will have to be rebooted.













### 7.5 Setting Up Technician User Passwords

16. Only the Login Master Password (2625) can set up Login User Passwords from the Login menu.
17. While the i4 is running, with the Login function on, the Factory Password (1234) entered, and the Login Master Password (2625) as the present login ID, Scroll to Custom B in the Double Sided weld menu. Press System Settings (closed circle button) and you will arrive in the Login menu.
18. Press Login ID Settings (down arrow).
19. Navigate with the Left and Right Arrow and Open Circle buttons. Set desired values (ex: 0003) with the Up and Down Arrow buttons. Once done press the Closed Circle button.
20. Passwords can now be added/changed. There is a maximum of 20 possible Login User Passwords available to be active.



## 8 i4 Log Feature

### 8.1 i4 Log Instructions

To access the LOG menu screen on the welder:

1. In the Welding screens: navigate with side arrow  to CUSTOM B 
2. Click SYSTEM SETTINGS 
3. Move cursor with side arrow  to LOG 
4. Click LOG MENU  The following options are available: SEND LOG TO USB, HEADER, CLEAR LOG, EXIT.
5. Click HEADER  to: edit Information that will appear on top of the weld data report
6. Click INCREASE  to select a character from A - 0
7. Click DECREASE  to select a character from A - 0, click Right side arrow to accept character and move right. Click Left Arrow to go back. Click NEXT VALUE  to move to the next subject (Vehicle Number) etc. click DONE  to proceed. The entered information is now placed in the LOG as a new heading. The previous logs with previous headings will remain in the log without being erased. Header info can be edited in MS Excel.
8. Click EXIT  twice go back to the Weld Screens.

#### To Clear Log:

9. Click CLEAR LOG  from the LOG MENU to: erase previous weld data in the log and to start a new header with no weld data in the log. Fill out the log (see above) click DONE  to proceed. click EXIT  twice go back to the Weld Screens

# 8 i4 Log Feature

## 8.2 Download the Log file for print

1. Take flash card out of the i4 and insert in a PC flash card reader.
2. Open the ADVANCED directory.
3. Open ad\_log directory.
4. Find PROSPOT.LOG file and copy it to your hard drive.
5. Open Weld\_Log directory, locate "Weld Log v1.2.xlt" template.
6. Open the template, click blue box "Process Log File"  
select the PRO SPOT.LOG file that you just copied to your hard drive.
7. The data should fill in respective rows and columns.

**NOTE:** i4 Data Log will not process if header information has not been properly entered, for reference please see the previous page of this document. Also, make sure that atleast one weld has been made on the machine before processing Data Log.

**IMPORTANT:** Do not save over Weld Log template file - Use the "Save As" function to save a copy.



Pro Spot international, Inc.  
2625 Temple Heights Dr Ste. A  
Oceanside, CA 92056

Toll Free: (877) PRO SPOT  
Fax: (760) 407-1414

E-mail: [info@prospot.com](mailto:info@prospot.com)  
Web: [www.prospot.com](http://www.prospot.com)

Copyright © Pro Spot International, Inc. 2005-2009

Process Log File Button  
Legend

**Sample of Pro Spot Weld Log template**

**PRO SPOT i4 WELD LOG**

**LEGEND:**  
 VDI: Veld Count  
 Date: Date of veld  
 Time: Time of veld  
 VTI: Veld duration veld (s)  
 SC1: Set Current Veld1 Amperage or %  
 MC1: Measured (actual) current 1  
 VTI2: Veld duration veld 2  
 SC2: Set Current Veld2 Amperage or %  
 MC2: Measured (actual) current 2  
 VTI3: Veld program no. 20% v. 2 sided welding HSG  
 ISSV: Single sided veld

Prog: 1,0.7mm, 2,1.0mm, 3,1.2mm, 4,1.5mm,5,2.0mm, 6,2.5mm  
 Eval: Evaluation of veld. OK= passed or FAILED  
 LogIn: User ID logged in at the time of veld.  
 Temp: Temperature of heastick of inverter  
 SQT: Spewce Time  
 HT: Hold Time  
 CT: Cool Time  
 VDI: Veld delay between Veld1 and Veld2 in Dual mode  
 US1: Upstroke Veld1 ms US2: Upstroke Veld2 ms  
 DS1: Downstroke Veld1 ms DS2: Downstroke Veld2 ms

Ph1: Primary voltage phase 1  
 Ph2: Primary voltage phase 2  
 Ph3: Primary voltage phase 3

**Process Log File**

| WCt  | Date      | Time     | WT1  | SC1   | MC1  | WT2 | SC2   | MC2 | WTy | Prog | Eval | LogIn | Temp | SQT  | HT   | CT   | VD | US1 | US2 | DS1 | DS2 | Ph1 | Ph2 | Ph3 |
|------|-----------|----------|------|-------|------|-----|-------|-----|-----|------|------|-------|------|------|------|------|----|-----|-----|-----|-----|-----|-----|-----|
|      |           |          | sec  | A / % | A    | sec | A / % | A   |     |      |      |       |      | ms   | ms   | ms   | ms | ms  | ms  | ms  | ms  | V   | V   | V   |
| 2441 | 8/20/2008 | 12:25:10 | 0.17 | 6870  | 6801 |     |       |     | 2GV | 1    | OK   | 1     | 027C | 1999 | 1000 | 2501 |    | 8   |     |     |     | 230 | 231 | 232 |
| 2442 | 8/20/2008 | 12:29:20 | 0.17 | 6870  | 6801 |     |       |     | 2GV | 1    | OK   | 1     | 027C | 1999 | 1000 | 2501 |    | 8   |     | 8   |     | 230 | 231 | 232 |
| 2443 | 8/20/2008 | 12:39:10 | 0.16 | 6870  | 6801 |     |       |     | 2GV | 1    | OK   | 1     | 027C | 1999 | 1000 | 2501 |    | 8   |     | 8   |     | 230 | 231 | 232 |
| 2444 | 8/20/2008 | 13:29:00 | 0.17 | 6870  | 6801 |     |       |     | 2GV | 1    | OK   | 1     | 027C | 1999 | 1000 | 2501 |    | 8   |     | 8   |     | 230 | 231 | 232 |
| 2445 | 8/21/2008 | 06:12:20 | 0.15 | 6870  | 6801 |     |       |     | 2GV | 1    | OK   | 1     | 027C | 1999 | 1000 | 2501 |    | 8   |     | 8   |     | 230 | 231 | 232 |
| 2446 | 8/21/2008 | 06:12:30 | 0.17 | 6870  | 6801 |     |       |     | 2GV | 1    | OK   | 1     | 027C | 1999 | 1000 | 2501 |    | 8   |     | 8   |     | 230 | 231 | 232 |
| 2447 | 8/21/2008 | 06:13:20 | 0.16 | 6870  | 6801 |     |       |     | 2GV | 1    | OK   | 1     | 027C | 1999 | 1000 | 2501 |    | 8   |     | 8   |     | 230 | 231 | 232 |
| 2448 | 8/21/2008 | 06:17:09 | 0.13 | 6870  | 6801 |     |       |     | 2GV | 1    | OK   | 1     | 028C | 1999 | 1000 | 2501 |    | 8   |     | 8   |     | 230 | 231 | 232 |
| 2449 | 8/22/2008 | 12:29:20 | 0.17 | 6870  | 6801 |     |       |     | 2GV | 1    | FAIL | 1     | 028C | 1999 | 1000 | 2501 |    | 8   |     | 8   |     | 000 | 000 | 000 |
| 2450 | 8/22/2008 | 12:31:20 | 0.13 | 6870  | 6801 |     |       |     | 2GV | 1    | OK   | 1     | 028C | 1999 | 1000 | 2501 |    | 8   |     | 8   |     | 230 | 231 | 232 |
| 2451 | 8/22/2008 | 12:33:10 | 0.15 | 6870  | 6801 |     |       |     | 2GV | 1    | OK   | 1     | 028C | 1999 | 1000 | 2501 |    | 8   |     | 8   |     | 230 | 231 | 232 |
| 2452 | 8/22/2008 | 12:34:20 | 0.17 | 6870  | 6801 |     |       |     | 2GV | 1    | OK   | 1     | 028C | 1999 | 1000 | 2501 |    | 8   |     | 8   |     | 230 | 231 | 232 |
| 2453 | 8/22/2008 | 12:35:25 | 0.14 | 6870  | 6801 |     |       |     | 2GV | 1    | OK   | 1     | 028C | 1999 | 1000 | 2501 |    | 8   |     | 8   |     | 230 | 231 | 232 |
| 2454 | 8/22/2008 | 12:36:08 | 0.17 | 6870  | 6801 |     |       |     | 2GV | 1    | OK   | 1     | 028C | 1999 | 1000 | 2501 |    | 8   |     | 8   |     | 230 | 231 | 232 |
| 2455 | 8/23/2008 | 12:29:21 | 0.17 | 6870  | 6801 |     |       |     | 2GV | 1    | OK   | 1     | 028C | 1999 | 1000 | 2501 |    | 8   |     | 8   |     | 230 | 231 | 232 |
| 2456 | 8/23/2008 | 12:30:20 | 0.17 | 6870  | 6801 |     |       |     | 2GV | 1    | OK   | 1     | 028C | 1999 | 1000 | 2501 |    | 8   |     | 8   |     | 230 | 231 | 232 |

Weld Data Information

Weld Log Header